

## Genus *Armascirus* (Acari: Prostigmata: Cunaxidae) from Pakistan

M. Hamid Bashir<sup>1\*</sup>, M. Afzal<sup>2</sup> & Bilal Saeed Khan<sup>3</sup>

<sup>1</sup> Assistant Professor, Department of Agri. Entomology, University of Agriculture, Faisalabad, Pakistan. (hamid\_uaf@yahoo.com). +92 321 6650959

<sup>2</sup> Associate Professor, Department of Agri. Entomology, University of Agriculture, Faisalabad, Pakistan. (chafzal64@yahoo.com). +92 300 7634963

<sup>3</sup> Lecturer, Department of Agri. Entomology, University of Agriculture, Faisalabad, Pakistan. (bsk\_1703@yahoo.com). +92 321 6646852

Corresponding author : \* Prof. M. Hamid Bashir, e-mail: hamid\_uaf@yahoo.com

**ABSTRACT.** Four new species of the genus *Armascirus*, namely *A. akhtari* n. sp., *A. jasmine* n. sp., *A. sabrii* n. sp. and *A. gojraensis* n. sp. are described and illustrated from Pakistan. Distribution records of four already known species (*A. satianaensis* Bashir & Afzal, *A. asghari* Bashir & Afzal, *A. mactator* Muhammad & Chaudhri and *A. pluri* Muhammad & Chaudhri) are given. A key to the species of the genus *Armascirus* from Pakistan is prepared and phenetic affinities of these species have been inferred.

**KEY WORDS:** Acari, Cunaxidae, *Armascirus*, Pakistan.

### INTRODUCTION

Mites belonging to the family Cunaxidae are well-known predators of harmful mites and small soft bodied insects (SMILEY, 1992). WALTER & KAPLAN (1991) found *Coleoscirus simplex* colonizes in greenhouse pot cultures infested with root knot nematodes (*Meloidogyne* spp.) in Florida, where it feeds on this nematode and other soil arthropods. They also studied the feeding behaviour of Cunaxidae. TAGORE & PUTATUNDA (2003) reported that cunaxid mites were important predators in ornamental plants in Haryana, India.

*Armascirus*, an important genus of the family Cunaxidae, was erected by DEN HEYER (1978) designating *A. huyssteeni* as its type species. MUHAMMAD & CHAUDHRI (1991) collected and described two new species, *A. mactator* and *A. pluri* from Pakistan. BASHIR & AFZAL (2005) reported two new species *A. satianaensis* and *A. asghari* from this region. During surveys of different climatic regions of Punjab- Pakistan four new species of the genus *Armascirus*, namely *A. akhtari* n. sp., *A. jasmine* n. sp., *A. sabrii* n. sp. and *A. gojraensis* n. sp were collected from leaf debris and are herein described and illustrated, making a total of eight species of this genus now known from Pakistan.

### MATERIALS AND METHODS

Mites were extracted from samples of leaf debris processed through Berlese's funnel for at least 24 hours, collected in a beaker containing 50% alcohol, then preserved in small vials containing 70% alcohol and few drops of glycerine. The cunaxid mites were sorted out under a binocular microscope and permanent slides were prepared using Hoyer's medium. The mounted specimens were identified using a phase contrast microscope and sketches were prepared with the aid of an ocular grid. Identifica-

tion of the species was done with the help of the existing keys and literature of SMILEY (1975; 1992), DEN HEYER (1978) and BASHIR & AFZAL (2005). The setal nomenclature of SMILEY (1992) has been followed. All the measurements (in  $\mu\text{m}$ ) and ranges are given in the description. The following abbreviations are used in this manuscript.

|     |                        |
|-----|------------------------|
| asl | attenuated solenidion  |
| bsl | blunt-ended solenidion |
| sts | simple tactile setae   |
| T   | trichobothrium         |

The phenetic relationships of all the known species of this genus from Pakistan have been worked out by multivariate cluster analysis using average linkage method and Euclidean distance by applying the computer software Minitab 13.1. Twenty four morphological characters were used (Table 1), and the result of cluster analysis is depicted in the dendrogram (Fig. 5).

### RESULTS

#### Key to species of genus *Armascirus* known from Pakistan

- 1) Dorsal hysterosoma with lateral reticulated shields. . . . . 2  
Dorsal hysterosoma without lateral shields . . . . . 7
- 2) Venter with 6 pairs of simple setae between coxae II and genital region. . . . . 3  
Venter with 7 pairs of simple setae between coxae II and genital region. . . . . 6
- 3) Palp genu with 3 spine-like setae and one simple seta. 4  
Palp genu with only 3 spine-like setae  
. . . . . *satianaensis* Bashir & Afzal
- 4) Coxa IV with 2 setae; genu II with 8 setae  
. . . . . *akhtari* n. sp.  
Coxa IV with 3 setae; genu II with 7 setae . . . . . 5

- 5) Genu I with 9 setae; genital valve with longitudinal rows of dot-like lobes  
 ..... *mactator*-Muhammad & Chaudhri  
 Genu I with 8 setae; genital valve with random dot-like lobes  
 ..... *pluri* Muhammad & Chaudhri
- 6) Basifemora I-IV with 4-5-4-2 setae; genu I with 8 setae  
 ..... *asghari* Bashir & Afzal  
 Basifemora I-IV with 5-5-3-2 setae; genu I with 7 setae  
 ..... *jasmyna* n. sp.
- 7) Palp genu with 2 spine-like setae; genu I with 6 setae.  
 ..... *sabrii* n. sp.  
 Palp genu with 3 spine-like setae; genu I with 8 setae  
 ..... *gojraensis* n. sp.

**1. *Armascirus satianaensis* Bashir & Afzal**

*Armascirus satianaensis* Bashir & Afzal, 2005: 119

Known Distribution: Pakistan: Faisalabad

Known Source: Plant debris

**2. *Armascirus asghari* Bashir & Afzal**

*Armascirus akhtari* Bashir & Afzal, 2005: 117

Known Distribution: Pakistan: Faisalabad

Known Source: Plant debris

**3. *Armascirus mactator* Muhammad & Chaudhri**

*Armascirus mactator* Muhammad & Chaudhri, 1991: 50

Known Distribution: Pakistan: Faisalabad

Known Source: Cauliflower

**4. *Armascirus pluri* Muhammad & Chaudhri**

*Armascirus pluri* Muhammad & Chaudhri, 1991: 50

Known Distribution: Pakistan: Faisalabad, Toba Take Singh

Known Source : Plant debris and soil

**5. *Armascirus akhtari* Bashir, Afzal & Khan, new species**

(Figs 1 A – F)

**Female**

**Gnathosoma**

Gnathosoma 320 long and 110 wide. Hypostome covered with papillae, sub-rectangular in shape and cone-shaped distally, with 4 pairs simple hypognathal setae (hg<sub>1</sub>-hg<sub>4</sub>) and two pairs adoral setae (Fig. 1E).

Palp 5 segmented, all segments papillated, measuring 270. Chaetotaxy of palp as follows: trochanter none; basifemur with one simple seta; telofemur with one apophysis and one spine-like seta; genu with one long triangular apophysis, one simple seta and 3 spine-like setae; tibiotarsus terminating in a small claw, with 4 (1 long + 3 small) simple setae, and one small spine-like seta (Fig. 1C).

Chelicerae 160 long, terminating in a claw, dorsal and ventral sides with lobes, with one dorsolateral simple seta (Fig. 1D).

**Dorsum**

Body 470 long (without gnathosoma) and 330 wide. Propodosoma with reticulate sub-rectangular shield, orig-

inating behind the base of gnathosoma and extending to the anterior region of hysterosoma. Propodosomal shield with anterior and posterior sensillae PS<sub>1</sub>, PS<sub>2</sub> measuring 250, 300 respectively and propodosomal setae P<sub>1</sub>, P<sub>2</sub> both simple 8.75 and 10.0 long, respectively.

Hysterosoma separated from propodosoma by papillate striae. Hysterosoma with two reticulated lateral and one triangular reticulated median shield, latter with setae D<sub>2</sub> measuring 12.5. Setae L<sub>1</sub>, D<sub>1</sub>, D<sub>3</sub>, D<sub>4</sub>, D<sub>5</sub> present on dorsal hysterosomal membrane. Setae L<sub>1</sub> 11.25, D<sub>1</sub> 11.25, D<sub>3</sub> 15, D<sub>4</sub> 22.5 and D<sub>5</sub> 25 long, all simple. Hysterosoma with one pair of pores lateral in position, between setae D<sub>3</sub> and D<sub>4</sub> (Fig. 1A).

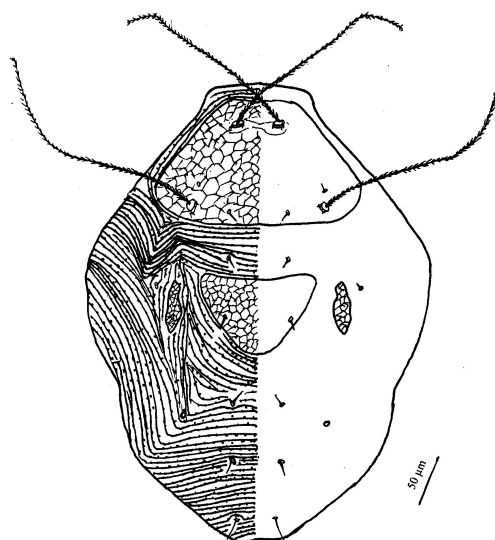


Fig. 1A. – *Armascirus akhtari* Bashir, Afzal & Khan, new species, Dorsal Side

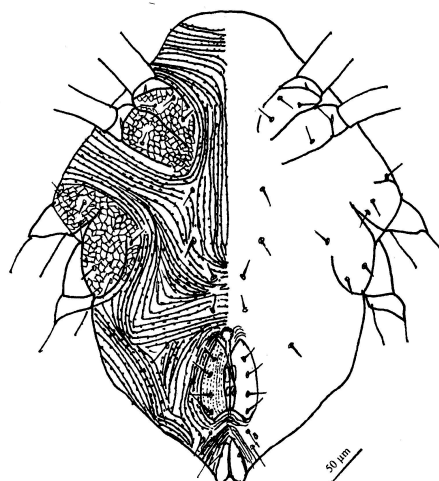
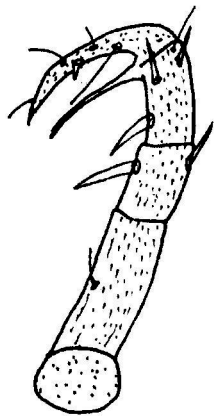
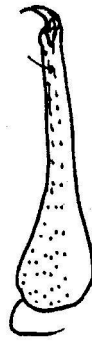


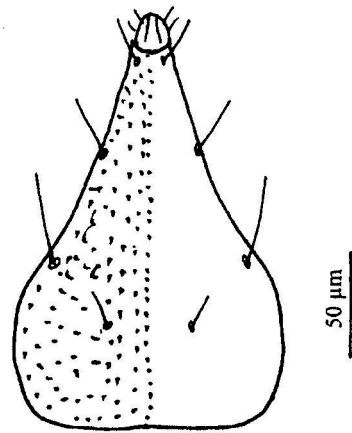
Fig. 1B. – *Armascirus akhtari* Bashir, Afzal & Khan, new species, Ventral Side



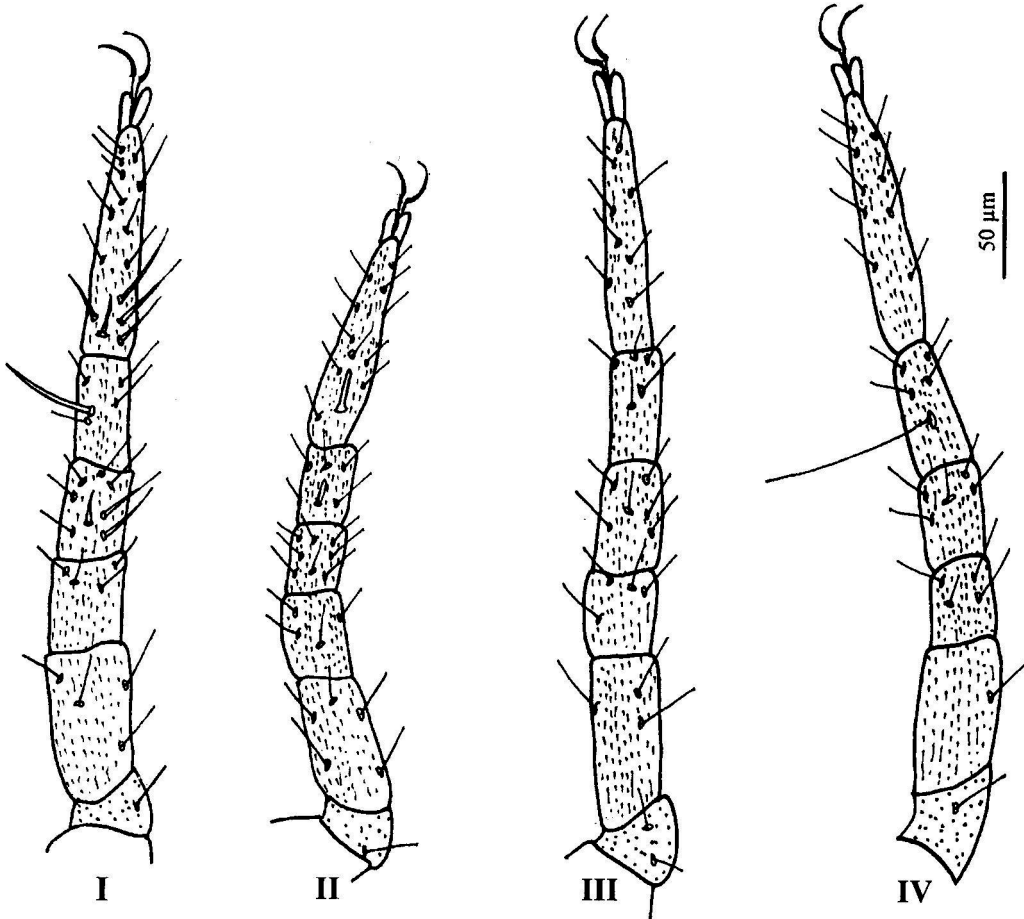
**Fig. 1 C**



**Fig. 1 D**



**Fig. 1 E**



**Fig. 1F**

- Fig. 1C. – *Armscirus akhtari* Bashir, Afzal & Khan, new species, Palp  
 Fig. 1D. – *Armscirus akhtari* Bashir, Afzal & Khan, new species, Chelicera  
 Fig. 1E. – *Armscirus akhtari* Bashir, Afzal & Khan, new species, E-Hypostome  
 Fig. 1F. – *Armscirus akhtari* Bashir, Afzal & Khan, new species, legs I-IV

### Venter

Venter with papillated striations. Coxae I-II and coxae III-IV contiguous and reticulated. Hysterosoma with 6 pairs of simple setae between coxae II and genital region. Genital valves covered with papillae arranged in rows, each valve with 4 simple genital setae ( $g_1$ - $g_4$ ) longitudinally aligned and 2 genital suckers. Anal setae (a) 1 pair, paranal setae (pa) 2 pairs. One pair minute pores near anal shield (Fig. 1B).

### Legs

Legs I-IV measuring (from trochanter base to the tip of tarsus) 333, 310, 370 and 380 respectively. All legs papillate, tarsi I-IV long, slender and attenuated, terminating in conspicuous lateral bilobed flanges. Chaetotaxy of legs I-IV as follows: Coxae 3-1-3-2; trochanters 1-1-2-1; basifemora 4-5-3-1; telofemora 4-4-4-4; genua 8 (3 asl + 5 sts)-8-6-5; tibiae 5(1 asl + 4 sts)- 6(1 bsl + 5 sts)-5-5(1 T + 4 sts) and tarsi 15(5 asl + 10 sts)- 12(1 bsl + 11 sts)-8-9 (Fig. 1F).

### Male

Unknown.

### Type

Holotype female, collected from University of Agriculture (Faisalabad) from leaf debris on 01-08-2004 (Hamid) and deposited in Acarology Research Laboratory, Department of Agri. Entomology, University of Agriculture Faisalabad – Pakistan.

### Etymology

This species is named in honour of Prof. Dr. Akhtar.

### Remarks

This new species can be separated from *Armscirus mactator* Muhammad & Chaudhri by the following characters.

1. Palp telofemur with 2 spine-like setae in *A. mactator* as against only one in this new species.

2. Chaetotaxy of legs I-IV in *A. mactator* is: coxae 3-2-3-3; basifemora 5-5-4-2; genua 9-7-6-7; tibiae 7-6-6-5 and tarsi 29-24-22-21 whereas in the new species chaetotaxy of legs I-IV is, coxae 3-1-3-2; basifemora 4-5-3-1; genua 8-8-6-5; tibiae 5-6-5-5 and tarsi 15-12-8-9.

This new species can also be separated from *A. pluri* Muhammad & Chaudhri by the following characters.

1. Palp telofemur with one spine-like seta and two apophyses in *A. pluri*, while palp telofemur has one spine-like seta and one apophysis in this new species.

2. In *A. pluri* genital shield with scattered papillae but in this new species genital shield with papillae arranged in rows.

3. In *A. pluri* leg segments I-IV coxae; basifemora; genua; tibiae and tarsi with 3-2-3-3; 5-5-4-2; 8-7-6-7; 6-5-6-5 and 29-25-23-22 setae respectively as against 3-1-3-2; 4-5-3-1; 8-8-6-5; 5-6-5-5 and 15-12-8-9 in this new species.

This new species also relates to *A. heryfordi* Smiley in that:

1. Hysterosomal shield triangular in this new species while it is squarish in *A. heryfordi*.

2. Ventral hysterosoma with 5 pairs of simple setae between coxae II and genital region in *A. heryfordi* as against 6 pairs in this new species.

This new species can also be separated from *A. huyssteeni* den Heyer and *A. taurus* (Kramer) by the setal counts of legs I-IV.

### 6. *Armscirus jasminea*, Bashir, Afzal & Khan, new species (Figs 2 A – F)

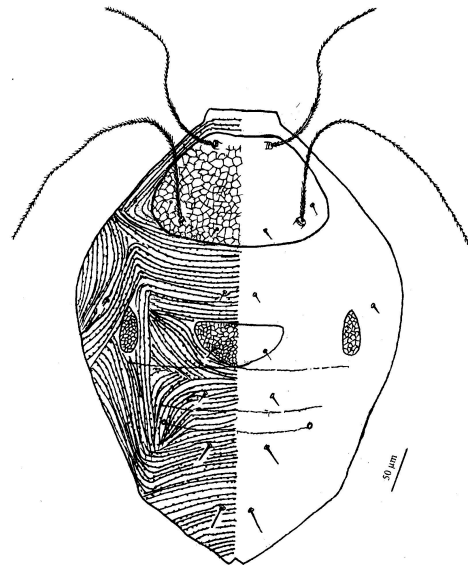


Fig. 2A. – *Armscirus jasminea*, Bashir, Afzal & Khan, new species, Dorsal Side

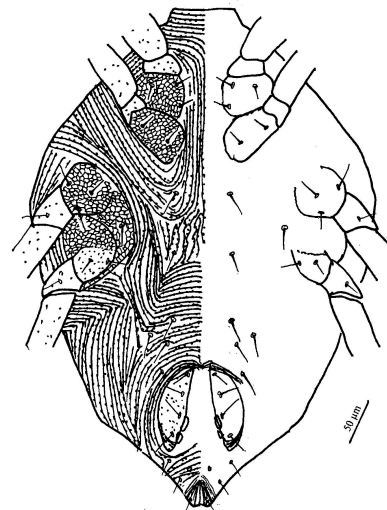
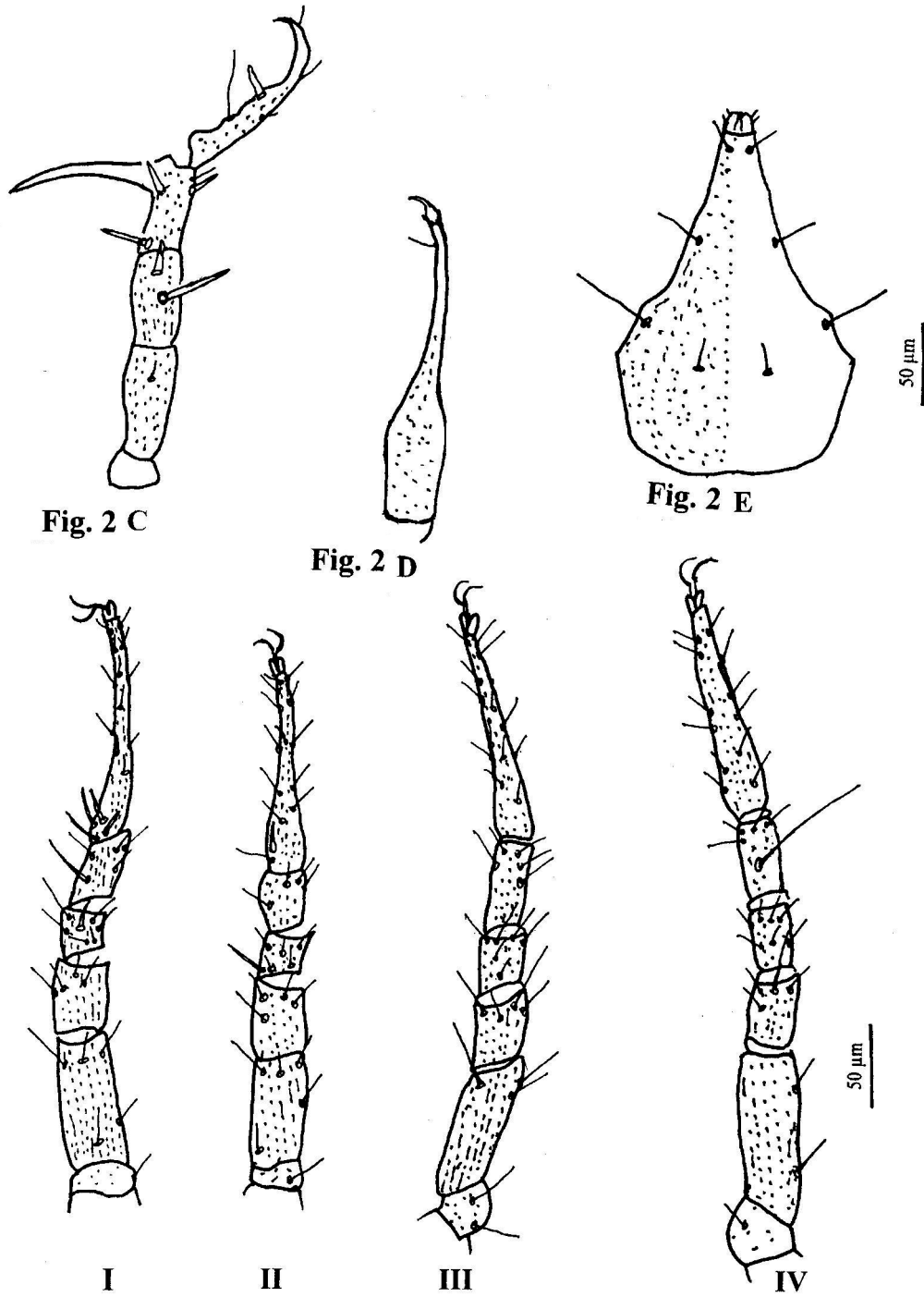


Fig. 2B. – *Armscirus jasminea*, Bashir, Afzal & Khan, new species, Ventral Side



**Fig. 2 C**

**Fig. 2 D**

**Fig. 2 E**

**Fig. 2 F**

Fig. 2C. *Armscirus jasmına*, Bashir, Afzal & Khan, new species, Palp

Fig. 2D. *Armscirus jasmına*, Bashir, Afzal & Khan, new species, Chelicera

Fig. 2E. *Armscirus jasmına*, Bashir, Afzal & Khan, new species, Hypostome

Fig. 2F. *Armscirus jasmına*, Bashir, Afzal & Khan, new species, legs I-IV

**Female****Gnathosoma**

Gnathosoma 421 (411-450) long and 117 (108-118) wide. Hypostome papillate, sub-rectangular in shape and cone-shaped distally; with 4 pairs simple hypognathal setae ( $hg_1$ - $hg_4$ ) and two pairs adoral setae (Fig. 2E).

Palp 5 segmented, all segments papillate, measuring 320 (310-320). Chaetotaxy of palp as follows: trochanter none; basifemur with one simple seta; telofemur with one apophysis and one spine-like seta; genu with one long triangular apophysis, one simple seta and 3 spine-like setae; tibiotarsus terminating in a small claw, with 4 (1 long + 3 small) simple setae, and one thick, stout spine-like seta (Fig. 2C).

Chelicera 180 (180-200) long, terminating in a claw, dorsal and ventral sides with lobes, with one dorsolateral simple seta (Fig. 2D).

**Dorsum**

Body 510 (510-588) long (without gnathosoma) and 402 (323-441) wide.

Propodosoma with reticulated subrectangular shield, originating behind the base of gnathosoma and extending to the anterior region of hysterosoma. Propodosomal shield with anterior and posterior sensillae  $PS_1$ ,  $PS_2$  measuring 284 (265-284), 411 (385-411) respectively and propodosomal setae  $P_1$ ,  $P_2$  both simple 12 (11-14) and 12 (11-12) long, respectively.

Hysterosoma separated from propodosoma by papillate striae. Hysterosoma with two lateral reticulated shields and one triangular reticulated median shield with setae  $D_2$  measuring 12 (12-14). Setae  $L_1$ ,  $D_1$ ,  $D_3$ ,  $D_4$ ,  $D_5$  present on dorsal hysterosomal membrane. Setae  $L_1$  11 (11-12),  $D_1$  10 (10-12),  $D_3$  13 (13-15),  $D_4$  36 (34-36) and  $D_5$  36 (36-38) long, all simple. Hysterosoma with one pair of lateral pores between setae  $D_3$  and  $D_4$  (Fig. 2A).

**Venter**

Venter with papillate striations. Coxae I-II and coxae III-IV contiguous and reticulated. Hysterosoma with 7 pairs of simple setae between coxae II and genital region. Genital shield with two valves having random papillae, each valve with 4 simple genital setae ( $g_1$ - $g_4$ ) in a longitudinal row and 2 genital suckers. Anal setae (a) 1 pair, paranal setae (pa) 2 pairs. One pair of minute pores near anal shield (Fig. 2B).

**Legs**

Legs I-IV measuring (from trochanter base to the tip of tarsus) 402 (402-412), 352 (253-382), 411 (411-421) and 460 (460-490) respectively. All legs with papillae, tarsi I-IV long, slender and attenuated, terminating in conspicuous lateral bilobed flanges. Chaetotaxy of legs I-IV as follows: coxae 3-2-3-2; trochanters 1-1-2-1; basifemora 5-5-3-2; telofemora 4-4-4-4; genua 7 (1 asl + 6 sts)-6(1 asl

+ 5 sts)-6-7; tibiae 5(1 asl + 4 sts)-4-5-5(1 T + 4 sts) and tarsi 16(4 asl + 12 sts)-14(1 asl + 13 sts)-13-12 (Fig. 2F).

**Male**

Unknown.

**Types**

Holotype female, collected at Faisalabad from leaf debris on 02-08-2004 (Hamid). Five female paratypes were collected from Faisalabad on 13-06-2004, one from Multan on 17-06-2004, five from Faisalabad on 13-06-2004, two from Bahawalpur on 12-08-2004, six from Lahore on 28-08-2004, two from Sialkot on 11-07-2004 and three from Rahim Yar Khan on 16-08-2004. All were collected from leaf debris and deposited in Acarology Research Laboratory, Department of Agri. Entomology, University of Agriculture Faisalabad – Pakistan.

**Etymology**

This species epithet refers to the source of collection. i.e. dried leaves of jasmine (*Jasminum grandiflorum*: Jasm.aceae)

**Remarks**

This new species is very similar to *A. heryfordi* Smiley but can be separated from it as followings:

1. Dorsal hysterosoma with rectangular reticulated shield in *A. heryfordi* while in *A. jasm. n. sp.* hysterosoma with triangular reticulated shield.

2. Venter with 5 pairs of simple setae between coxae II and genital region in *A. heryfordi* as against 7 pairs in *A. jasm. n. sp.*

3. Chaetotaxy of coxae; basifemora; genua; tibiae and tarsi of *A. heryfordi* with 3-2-3-3; 5-5-4-2; 8-7-6-7; 7-6-6-5 and 19-13-13-13 setae respectively but in new species with 3-2-3-2; 5-5-3-2; 7-6-6-7; 5-4-5-5 and 16-14-13-12 setae respectively.

This new species can also be separated from *A. gimpeli* Smiley by the following characters:

1. Lateral hysterosomal shields absent in *A. gimpeli* while they are present in this new species.

2. Venter with 6 pairs of simple setae between coxae II and genital region in *A. gimpeli* as against 7 pairs in this new species.

3. Both species differ in setal counts on legs I-IV.

This new species is also similar to *A. taurus* (Kramer), but can be separated from it by the following characters:

1. Palp genu with two simple setae in *A. taurus* while palp genu with one seta in this new species.

2. Venter with 6 pairs of simple setae between coxae II and genital region in *A. taurus* as against 7 pairs in this new species.

3. Both species differ in setal counts of legs.

**7. *Armascirus sabrii***, Bashir, Afzal & Khan,  
new species  
(Figs 3 A – F)

**Female****Gnathosoma**

Gnathosoma 265 (265-274) long and 78 (78-88) wide. Hypostome papillate, sub-rectangular in shape and cone-shaped distally with almost parallel sides, with 4 pairs simple hypognathal setae ( $hg_1$ - $hg_4$ ) and two pairs adoral setae (Fig. 3E).

Palp 5 segmented, all segments papillate, measuring 210 (205-210). Chaetotaxy of palp as follows: trochanter none; basifemur with one simple seta; telofemur with one apophysis and one spine-like seta; genu with one long triangular apophysis, one simple seta and 2 spine-like setae; tibiotarsus terminating in a small claw, with 4 (3 small and 1 long) simple setae and one thick spine-like seta (Fig. 3C).

Chelicera 110 (110-115) long, terminating in a claw, dorsal and ventral sides with lobes, with one dorsolateral simple seta (Fig. 3D).

**Dorsum**

Body 412 (392-412) long (without gnathosoma) and 303 (274-303) wide.

Propodosoma with reticulated sub-triangular shield, originating behind the base of gnathosoma and extending to the anterior region of hysterosoma. Propodosomal shield with anterior and posterior sensillae  $PS_1$ ,  $PS_2$  measuring 245 (196-245), 284 (265-284) respectively and propodosomal setae  $P_1$ ,  $P_2$  both simple 8 (7-8) and 8 (7-8) long, respectively.

Hysterosoma separated from propodosoma by striations bearing papillae. Hysterosoma with only one triangular reticulated median shield with setae  $D_2$  measuring 10 (8-10). Setae  $L_1$ ,  $D_1$ ,  $D_3$ ,  $D_4$  and  $D_5$  present on dorsal hysterosomal membrane. Setae  $L_1$  10 (8-10),  $D_1$  7 (7-8),  $D_3$  16 (14-16),  $D_4$  24 (24-26) and  $D_5$  25 (25-27) long, all simple. Hysterosoma with one pair of pores lateral in position, between setae  $D_3$  and  $D_4$  (Fig. 3A).

**Venter**

Venter with papillated striations. Coxae I-II and coxae III-IV contiguous and reticulated. Hysterosoma with 5 pairs of simple setae between coxae II and genital region. Genital shield with two valves having random papillae, each valve with 3 simple genital setae ( $g_1$ - $g_3$ ) in a longitudinal row and 2 genital suckers. Anal setae (a) 1 pair, paranal setae (pa) 2 pairs. One pair of minute pores near anal shield (Fig. 3B).

**Legs**

Legs I-IV measuring (from trochanter base to the tip of tarsus) 274 (265-274), 245 (225-245), 284 (265-284) and 294 (284-294) respectively. All legs with papillae, tarsi I-IV long, slender and attenuated, terminating in conspicuous lateral bilobed flanges. Chaetotaxy of legs I-IV as follows: Coxae 3-1-3-2; trochanters 1-1-2-1; basifemora 1-2-1-0; telofemora 4-4-4-4; genua 6-7-5-6; tibiae 5(1 asl +

4 sts)-5-5(1 bsl + 4 sts)-5(1 T + 4 sts) and tarsi 11(2 asl + 9 sts)-7(1 bsl + 6 sts)-5-5 (Fig. 3F).

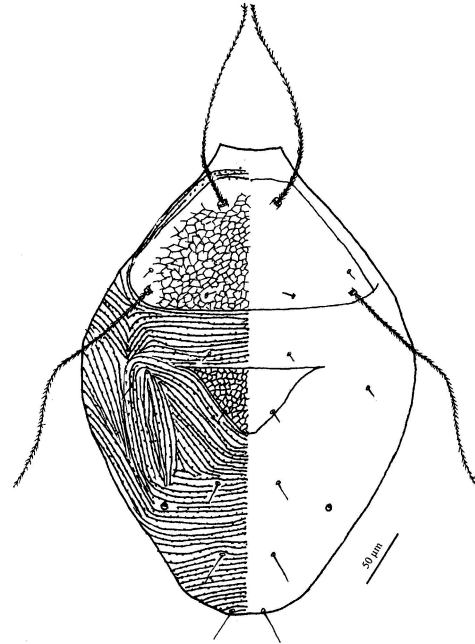


Fig. 3A. – *Armscirus sabrii*, Bashir, Afzal & Khan, new species, Dorsal Side

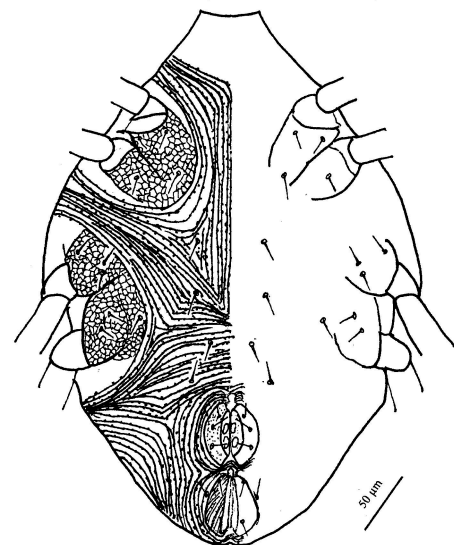
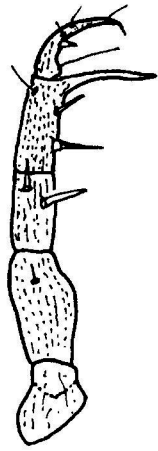


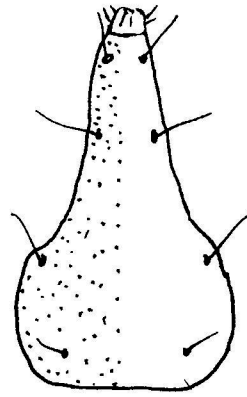
Fig. 3B. – *Armscirus sabrii*, Bashir, Afzal & Khan, new species, Ventral Side



**Fig. 3 C**

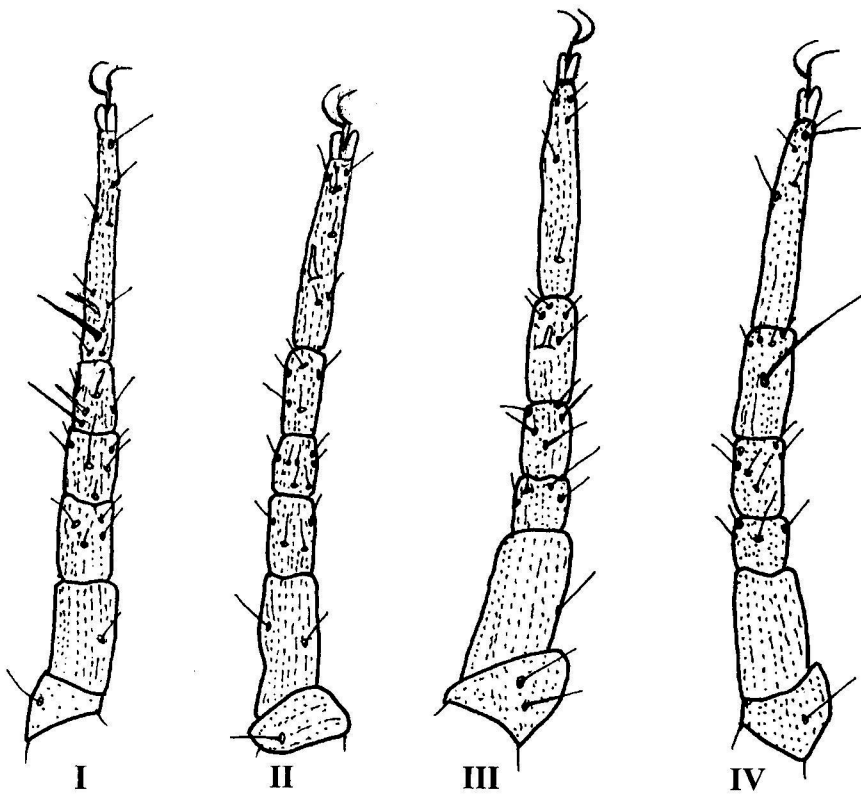


**Fig. 3 D**



**Fig. 3 E**

50  $\mu$ m



50  $\mu$ m

**Fig. 3 F**

Fig. 3C. *Armascirus sabrii*, Bashir, Afzal & Khan, new species, Palp

Fig. 3D. *Armascirus sabrii*, Bashir, Afzal & Khan, new species, Chelicera

Fig. 3E. *Armascirus sabrii*, Bashir, Afzal & Khan, new species, Hypostome

Fig. 3F. *Armascirus sabrii*, Bashir, Afzal & Khan, new species, legs I-IV



**Male**

Unknown.

**Types**

Holotype female, collected Faisalabad from leaf debris on 16-04-2004 (Hamid). Five female paratypes were collected from Faisalabad on 16-04-2004 and one was collected from Kahror Paka (Lodhran) on 20-07-2004. All were collected from leaf debris and deposited in Acarology Research Laboratory, Department of Agri. Entomology, University of Agriculture Faisalabad – Pakistan.

**Etymology**

This species is named for Mr. M. Altaf Sabry, a dedicated collector and researcher in the Department of Agri. Entomology, University of Agriculture, Faisalabad, Pakistan.

**Remarks**

This new species can be separated from *A. pluri* Muhammad & Chaudhri and *A. mactator* Muhammad & Chaudhri by the absence of a lateral reticulated shield.

This new species can also be separated from *A. lebowensis* den Heyer as follows:

1. Palp telofemur with two apophyses in *A. lebowensis* as against only one in *A. sabrii* n. sp.

2. Venter with 7 pairs of simple setae between coxae II and genital region in *A. lebowensis* where as in *A. sabrii* n. sp. venter with only 5 pairs of simple setae.

3. Chaetotaxy of legs I-IV in *A. lebowensis* as follows: basifemora 5-5-4-2; genua 9-7-6-6; tibiae 7-6-5-5 and tarsi 25-24-22-21 while chaetotaxy of legs I-IV in *A. sabrii* n. sp. as follow: basifemora 1-2-1-0; genua 6-7-5-6; tibiae 5-5-5-5 and tarsi 11-7-5-5.

This new species also closely resembles *A. gimpeli* Smiley, but can be separated from it by the following characters:

1. Palp genu with 3 spine-like setae in *A. gimpeli* while with two spine-like setae in this new species.

2. Venter with 6 pairs of simple setae between coxae II and genital region in *A. gimpeli* as against 5 pairs in this new species.

3. Both species differ in setal counts of legs.

4. Genital shield with 4 pairs of simple setae in *A. gimpeli* whereas genital shield with 3 pairs of simple setae in this new species.

**8. *Armscirus gojraensis***, Bashir, Afzal & Khan,  
new species  
(Figs 4 A – F)

**Female****Gnathosoma**

Gnathosoma 254 long and 78 wide. Hypostome flask-shaped, with 4 pairs simple hypognathal setae (hg<sub>1</sub>-hg<sub>4</sub>) and 2 pairs adoral setae (Fig. 4E).

Palp 5 segmented, all segments papillate, measuring 200. Chaetotaxy of palp as follows: trochanter none; bas-

ifemur with one simple seta; telofemur with one apophysis and one spine-like seta; genu with one long triangular apophysis, 3 spine-like setae and one simple seta; tibiotarsus terminating in a small claw; with 4 (1 long + 3 small) simple setae and one thick, stout spine-like seta (Fig. 4C).

Chelicera 140 long, terminating in a claw, dorsal and ventral sides with lobes, with one dorsolateral simple seta (Fig. 4D).

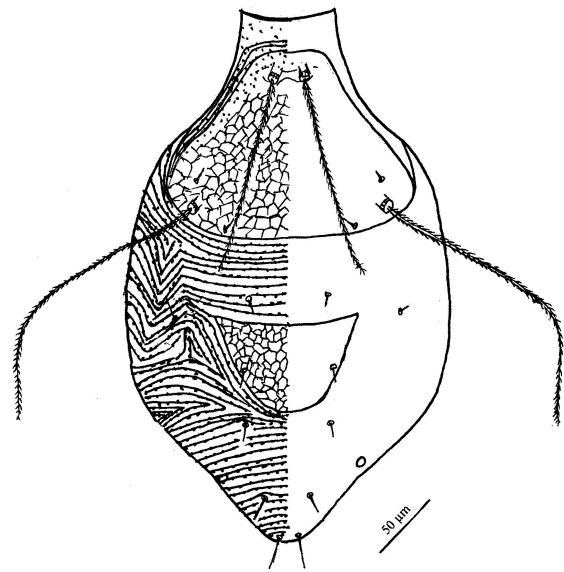


Fig. 4A. – *Armscirus gojraensis*, Bashir, Afzal & Khan, new species, Dorsal Side

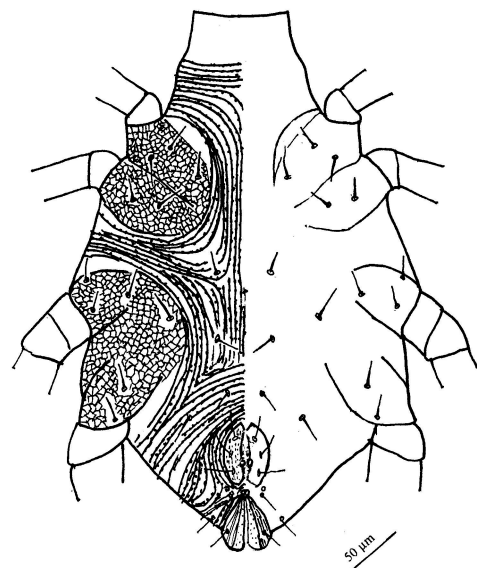


Fig. 4B. – *Armscirus gojraensis*, Bashir, Afzal & Khan, new species, Ventral Side

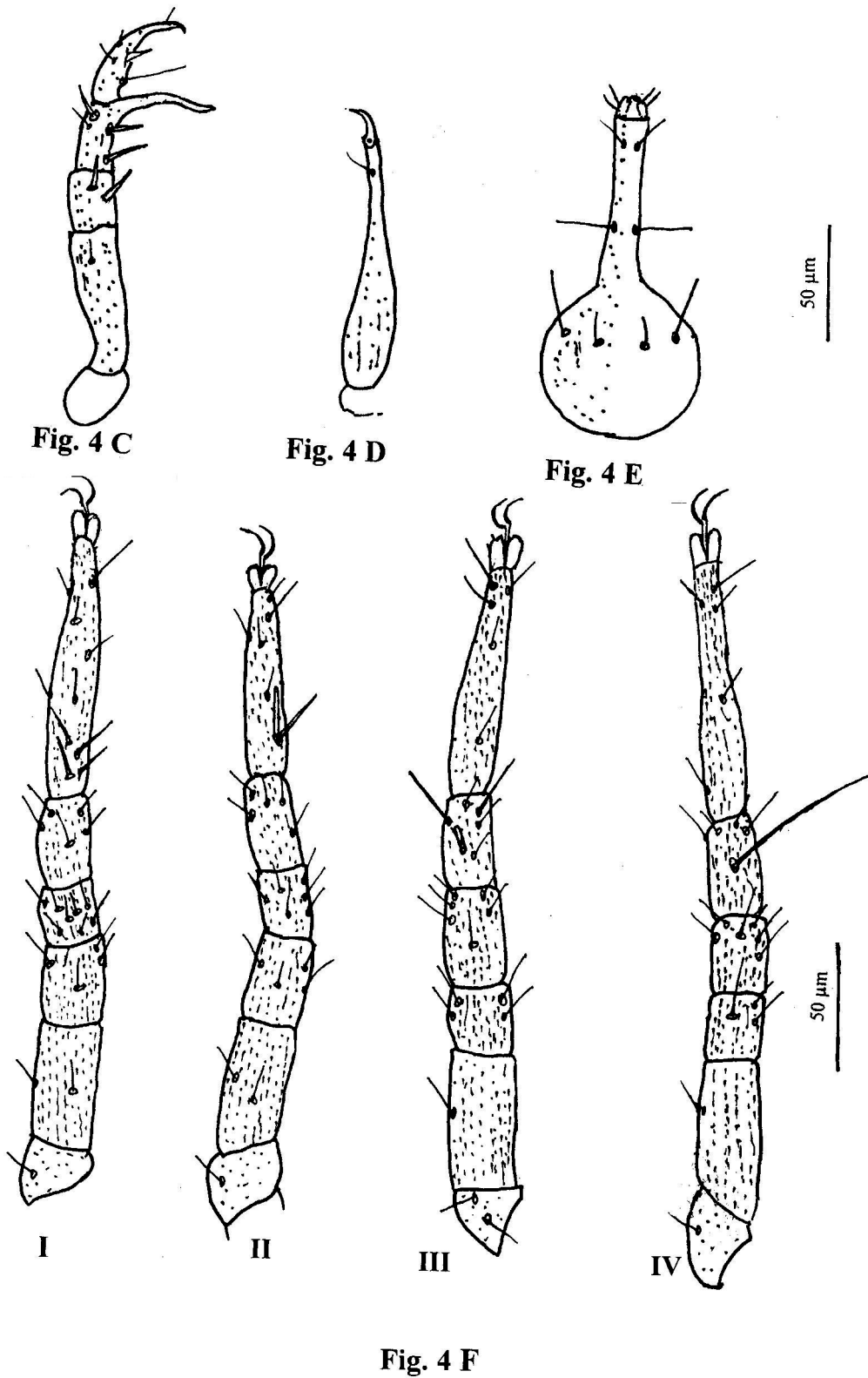


Fig. 4C. – *Armascirus gojaensis*, Bashir, Afzal & Khan, new species, Palp  
Fig. 4D. – *Armascirus gojaensis*, Bashir, Afzal & Khan, new species, Chelicera  
Fig. 4E. – *Armascirus gojaensis*, Bashir, Afzal & Khan, new species, Hypostome  
Fig. 4F. – *Armascirus gojaensis*, Bashir, Afzal & Khan, new species, legs I-IV

## Dorsum

Body 362 long (without gnathosoma) and 235 wide. Propodosoma with reticulated sub rectangular shield, originating behind the base of gnathosoma and extending to the anterior region of hysterosoma. Propodosomal shield with anterior and posterior sensillae PS<sub>1</sub>, PS<sub>2</sub> measuring 186, 264 respectively and propodosomal setae P<sub>1</sub> and P<sub>2</sub> both simple 8 and 10 long, respectively.

Hysterosoma separated from propodosoma by striae bearing papillae. Hysterosoma with only one triangular reticulated median shield with setae D<sub>2</sub> measuring 12. Setae L<sub>1</sub>, D<sub>1</sub>, D<sub>3</sub>, D<sub>4</sub>, D<sub>5</sub> present on dorsal hysterosomal membrane. Setae L<sub>1</sub> 9, D<sub>1</sub> 10, D<sub>3</sub> 12, D<sub>4</sub> 17 and D<sub>5</sub> 27 long, all simple. Hysterosoma with one pair of pores between seta D<sub>3</sub> and D<sub>4</sub> (Fig. 4A).

## Venter

Venter with papillated striations. Coxae I-II and coxae III-IV contiguous and reticulated. Hysterosoma with 4 pairs of simple setae between coxae II and genital region. Genital shield with two valves having lobe like dots arranged in rows, each valve with 3 simple genital setae (g<sub>1</sub>-g<sub>3</sub>) in a row and 2 genital suckers. Anal setae (a) 1 pair, paranal setae (pa) 2 pairs. One pair of minute pores near anal shield (Fig. 4B).

## Legs

Legs I-IV measuring (from trochanter base to the tip of tarsus) 264, 254, 284 and 303 respectively. All legs with papillae, tarsi I-IV long, slender and attenuate, terminating into conspicuous lateral bilobed flanges. Chaetotaxy of legs I-IV as follows: Coxae 3-2-3-3; trochanters 1-1-2-1; basifemora 2-2-1-1; telofemora 4-4-4-3; genua 8-6-6-6; tibiae 5-5-6(1 bsl + 5 sts)-5(1 T + 4 sts) and tarsi 10(4 asl + 6 sts)-7(1 asl + 1 bsl + 5 sts)-5-5 (Fig. 4F).

## Male

Unknown.

## Type

Holotype female, collected Gojra (T.T. Singh), Pakistan, from leaf debris on 06-08-2004 (Hamid) and deposited in Acarology Research Laboratory, Department of Agri. Entomology, University of Agriculture Faisalabad - Pakistan.

## Etymology

This species epithet is for the type locality.

## Remarks

This new species can be separated from *A. limpopoensis* den Heyer as follows:

1. Palp telofemur in *A. limpopoensis* with one triangular apophysis but in this new species this triangular apophysis is absent.

2. Venter with 7 pairs of simple setae between coxae II and genital region in *A. limpopoensis* as against 5 pairs in this new species.

3. Chaetotaxy of legs I-IV in *A. limpopoensis* as follows: basifemora 5-5-4-2; telofemora 4-4-4-4; genua 8-7-6-8; tibiae 8-6-6-5 and tarsi 25-25-23-21 whereas in the new species chaetotaxy of legs I-IV as follows: basifemora 2-2-1-1; telofemora 4-4-4-3; genua 8-6-6-6; tibiae 5-5-6-5 and tarsi 10-7-5-5.

This new species can also be separated from *A. gimpeli* Smiley by the following characters:

1. Genital shield with 4 pairs of simple setae in *A. gimpeli* while genital shield with 3 pairs of simple setae in *A. gojraensis* n. sp.

2. Both species differ in setal counts of legs I-IV.

3. Venter with 6 pairs of simple setae between coxae II and genital region in *A. gimpeli* as against 4 pairs in *A. gojraensis* n. sp.

This new species also resembles to *A. taurus* (Kramer), but can be separated from it by the following characters.

1. Hysterosomal lateral shields are absent in this new species while lateral shields are present in *A. taurus*.

2. Venter with 6 pairs of simple setae between coxae II and genital region in *A. taurus* as against 4 pairs in this new species.

3. Genital shield with 4 pairs of simple setae in *A. taurus* while with 3 pairs in this new species.

4. Setal counts on legs I-IV differ in both species.

## DISCUSSION

DEN HEYER erected the genus *Armascirus* in 1978 and designated *A. huyssteeni* as its type species. He placed this genus under the subfamily Cunaxinae, tribe Armascirini, which also includes the genus *Dactyloscirus* Berlese, 1916. Some important works on this genus were published by SEPASGOSARIAN (1984) and LIANG (1985), but major contributions are by SMILEY (1992) who added five new species and made a total of ten species in this genus. From Pakistan a total of eight species (including four new species herein described) have been recorded.

The dendrogram of genus *Armascirus* (Fig. 5) depicts the highest similarity (92.76%) between the species *mactator* and *pluri*: both share the same habitat (Faisalabad) in central Punjab and are exposed to similar environmental factors. The species *jasmima* and *asghari*, both from discrete localities in the Punjab, show a similarity of 90.53% with each other. The species *akhtari* and *satianaensis*, both from same locality and sharing 79.72% characters, join the *jasmima* – *asghari* pair at 74.50% affinity level, whereas *gojraensis* – *sabrii* pair having an affinity of 89.41% also from the same locality join this cluster at 69.91% affinity level, thus forming a big cluster. The species pair *mactator* – *pluri* join the large cluster sharing weak phenetic affinity of only 21.97%.

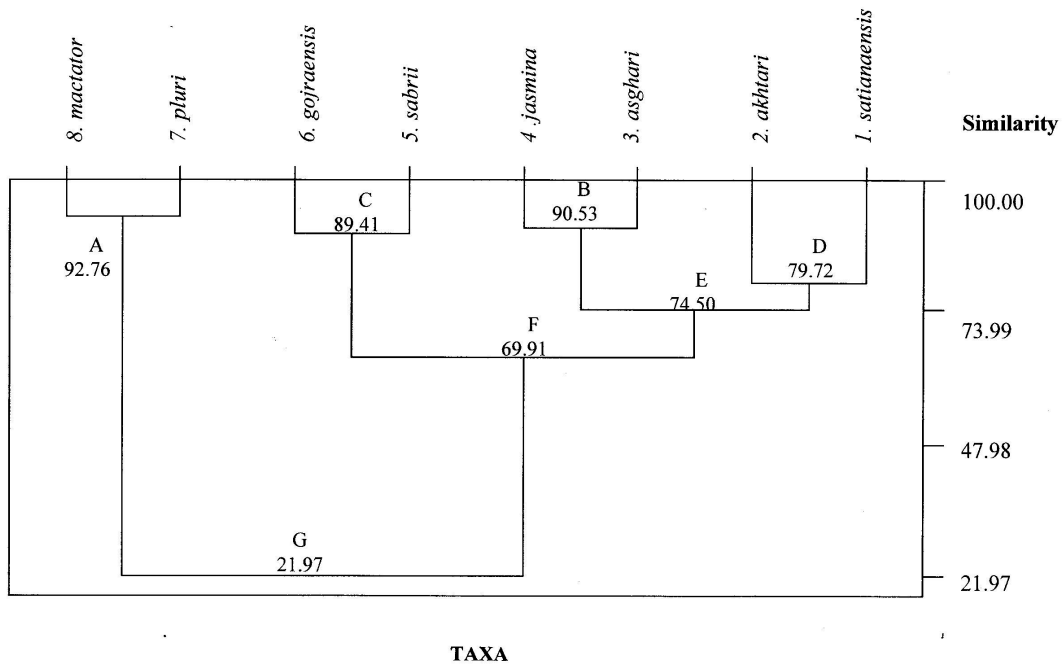


Fig. 5. – Dendrogram of 8 species of the genus *Armascirus* from Pakistan

TABLE 1

Prevalence of 24 characters in 8 species of the Genus *Armascirus* (Acari; Cunaxidae) from Pakistan.

| Characters | Species             |                |                |                |               |                   |              |                 |
|------------|---------------------|----------------|----------------|----------------|---------------|-------------------|--------------|-----------------|
|            | <i>satianaensis</i> | <i>akhtari</i> | <i>asghari</i> | <i>jasmima</i> | <i>sabrii</i> | <i>gojraensis</i> | <i>pluri</i> | <i>mactator</i> |
| I          | 3                   | 3              | 3              | 3              | 2             | 3                 | 3            | 3               |
| II         | 0                   | 1              | 1              | 1              | 1             | 1                 | 1            | 1               |
| III        | 1                   | 1              | 1              | 1              | 0             | 0                 | 1            | 1               |
| IV         | 12                  | 12             | 14             | 14             | 10            | 10                | 12           | 12              |
| V          | 4                   | 4              | 4              | 4              | 3             | 3                 | 4            | 4               |
| VI         | 4                   | 4              | 3              | 3              | 3             | 4                 | 3            | 4               |
| VII        | 2                   | 1              | 2              | 2              | 1             | 2                 | 2            | 2               |
| VIII       | 2                   | 2              | 2              | 2              | 2             | 3                 | 3            | 3               |
| IX         | 4                   | 4              | 4              | 5              | 1             | 2                 | 5            | 5               |
| X          | 4                   | 5              | 5              | 5              | 2             | 2                 | 5            | 5               |
| XI         | 3                   | 3              | 4              | 3              | 1             | 1                 | 4            | 4               |
| XII        | 3                   | 1              | 2              | 2              | 0             | 1                 | 2            | 2               |
| XIII       | 4                   | 4              | 4              | 4              | 4             | 3                 | 4            | 4               |
| XIV        | 8                   | 8              | 8              | 7              | 6             | 8                 | 8            | 9               |
| XV         | 4                   | 8              | 6              | 6              | 7             | 6                 | 7            | 7               |
| XVI        | 6                   | 6              | 6              | 6              | 5             | 6                 | 6            | 6               |
| XVII       | 7                   | 5              | 6              | 7              | 6             | 6                 | 7            | 7               |
| XVIII      | 6                   | 5              | 6              | 5              | 5             | 5                 | 6            | 7               |
| XIX        | 5                   | 6              | 5              | 4              | 5             | 5                 | 5            | 6               |
| XX         | 6                   | 5              | 6              | 5              | 5             | 6                 | 6            | 6               |
| XXI        | 11                  | 15             | 18             | 16             | 11            | 10                | 29           | 29              |
| XXII       | 10                  | 12             | 15             | 14             | 7             | 7                 | 25           | 24              |
| XXIII      | 9                   | 8              | 13             | 13             | 5             | 5                 | 23           | 22              |
| XXIV       | 7                   | 9              | 12             | 12             | 5             | 5                 | 22           | 21              |

I, Spines on palp genu; II, Setae on palp genu; III, Long triangular apophysis on palp genu (0, absent; 1, present); IV, Setae on ventral hysterosoma; V, Setae on genital shield; VI, Genital shield (1, smooth; 2, striated; 3, random dots; 4, with dots arranged in rows); VII, Setae on Coxa II; VIII, Setae on Coxa IV; IX, Setae on basifemur I; X, Setae on basifemur II; XI, Setae on basifemur III; XII, Setae on basifemur IV; XIII, Setae on telofemur IV; XIV, Setae on genu I; XV, Setae on genu II; XVI, Setae on genu III; XVII, Setae on genu IV; XVIII, Setae on tibia I; XIX, Setae on tibia II; XX, Setae on tibia III; XXI, Setae on tarsus I; XXII, Setae on tarsus II; XXIII, Setae on tarsus III; XXIV, Setae on tarsus IV.

The observed similarity might be due to the shared states of the chosen attributes, with the similarity increasing with the number of these shared attributes. Sometimes, however, we may restrict the attributes considered to only those that are relevant or similar in diagnostics in the sense that the characters chosen are shared only by some but not by all the species under consideration. According to JORDINE & SIBSON (1971), a similarity may thus be converted into dissimilarity for any fixed list of attributes in such cases.

KOHN & ORIONS (1962) have argued that closely related species could exploit different niches through adaptation not involving conspicuous morphological character differences. This point was made earlier by DOBZHANSKY (1940) and SIMPSON (1953; 1961) who advocated that the adaptive value – be it morphological, ecological or physiological – of a species complex is the property of genotype. This observation has been condensed by WILSON (1965) who argued, in relation to phenotypic plasticity, that behaviour (distribution) is the part of phenotype most likely to become modified in response to changes in the environment. Future studies may reveal that the evolutionary plasticity of mite behaviour (distribution) provides an excellent avenue of adaptation.

LITTLEJOHN (1981) concluded that a discontinuous array of biological diversity exists, particularly when viewed in a spatially restricted situation, and to understand the mechanisms and processes responsible for the origin and maintenance of this diversity one should look into the environment to formulate a combined ecological and genetic analysis. It is with this respect that some assumptions have been made to stimulate further studies.

Regardless of what has been presented in this paper, there remain many issues – ecological, physiological, and behavioural or genetics – for further study in Cunaxid mites.

## REFERENCES

- BASHIR MH & AFZAL M (2005). New cunaxid mites of the genus *Armscirus* from Punjab – Pakistan. *Pakistan Journal of Agricultural Sciences*, 42(3-4): 117-122.
- DEN HEYER J (1978). Four new species of *Armscirus* gen. nov. (Prostigmata: Acari) from the Ethiopian Region. *Journal of Entomological Society of South Africa*, 41(2): 217-239.
- DOBZHANSKY T (1940). Speciation as a stage in evolutionary divergence. *American Naturalist*, 74: 312-321.
- JORDINE N & SIBSON N (1971). *Mathematical Taxonomy*. John Wiley and Sons, London. 286 pp.
- KOHN AJ & ORIONS GH (1962). Ecological data in the classification of closely related species. *Systematic Zoology*, 11: 119-127.
- LIANG GW (1985). New species and new record of cunaxid mites from China. *Acta Zootaxonomica Sinica*, 7: 79-81.
- LITTLEJOHN MJ (1981). Reproductive Isolation: a critical review. In: ATCHLEY WR & WOODRUFF D (eds), *Evolution and Speciation*. Cambridge University Press. 436 pp.
- MUHAMMAD T & CHAUDHRI WM (1991). Two new Cunaxid mites of the genus *Armscirus* (Acarina: Cunaxidae) from Pakistan. *Pakistan Entomologist*, 13(1-2): 50-55.
- SIMPSON GG (1953). *The major features of evolution*. Columbia University Press. New York. 285 pp.
- SIMPSON GG (1961). *Principles of Animal Taxonomy*. Columbia University Press. New York. 247 pp.
- SMILEY RL (1975). A generic revision of the mites of the family Cunaxidae (Acarina). *Annals of the Entomological Society of America*, 68(2): 227-244.
- SMILEY RL (1992). *The Predatory Mite Family Cunaxidae (Acari) of the World with a New Classification*. Indira Publishing House, 356 pp.
- SEPASGOSARIAN H (1984). The world genera and species of the family Cunaxidae (Actinedida: Acarida). *Zeitschrift für Angewandte Zoologie*, 71: 135-150.
- TAGORE A & PUTATUNDA BN (2003). Mites associated with some ornamental plants at Hisar, Haryana. *Pest Management and Economic Zoology*, 11(1): 37-44.
- WALTER DE & KAPLAN DT (1991). Observations on *Coleoscius simplex* (Acarina: Prostigmata), a predatory mite that colonizes greenhouse cultures of rootknot nematode (*Meloidogyne* spp.), and a review of feeding behaviour in the Cunaxidae. *Experimental and Applied Acarology*, 12(1-2): 47-59.
- WILSON EO (1965). A consistency test of phylogenies based on contemporaneous species. *Systematic Zoology*, 14: 214-230.

*Received: January 9, 2006*

*Accepted: March 11, 2008*