

ANTHROPOLOGICA ET PRAEHISTORICA

Bulletin de la
Société royale belge d'Anthropologie
et de Préhistoire

Bulletin van de
Koninklijke Belgische Vereniging
voor Anthropologie en Prehistorie

123/2012

2013



*Ce volume a été publié
grâce à l'appui de*

*Deze bundel werd gepubliceerd
met de steun van*

l'Institut royal des Sciences naturelles de Belgique • het Koninklijk Belgisch Instituut voor Natuurwetenschappen

et grâce au soutien financier de en met de financiële steun van

*la Fondation universitaire de Belgique • de Universitaire Stichting van België
la Politique scientifique fédérale • het Federal Wetenschapsbeleid
et du en het*

*Ministère de la Communauté Française de Belgique
(Direction de la Recherche scientifique & Service général du Patrimoine culturel)
Ministère de la Région Wallonne (Division du Patrimoine)
Fonds National de la Recherche Scientifique – FNRS*



Comité de Rédaction / Redactieraad

Rédactrice en chef / Hoofdredactrice : Anne Hauzeur
Membres / Leden : Nicolas Cauwe, Stéphane Louryan, Rosine Orban,
Caroline Polet, Marc Vander Linden

Comité de lecture

Leescomité

Damien Flas (Département de Préhistoire de l'Université de Liège), Mietje Germonpré (Koninklijk Belgisch Instituut voor Natuurwetenschappen), Anne Hauzeur (SARL Paléotime, France), Cécile Jungels (Musée de la Préhistoire en Wallonie, Flémalle), Stéphane Pirson (Service public de Wallonie), Hélène Rougier (California State University, Northridge), Patrick Semal (Institut royal des Sciences naturelles de Belgique).

Instructions aux auteurs / Richtlijnen voor auteurs / Guide for authors

<http://srbap.naturalsciences.be/>

Le Bulletin de la Société royale belge d'Anthropologie et de Préhistoire a une vocation strictement scientifique et se veut ouvert à toutes les thèses scientifiques, sans parti pris idéologique ou dogmatique.

Aussi le contenu du Bulletin de la Société royale belge d'Anthropologie et de Préhistoire est-il contrôlé par un comité de rédaction permanent et des comités de lecture internationaux, établis en fonction du thème de chaque contribution. Ces différents comités n'ont aucun droit d'établir une censure, sinon en l'absence d'une démarche scientifique manifeste. Dans tous les cas, les auteurs sont responsables du contenu de leurs articles.

Het tijdschrift van de Koninklijke Belgische Vereniging voor Antropologie en Prehistorie heeft enkel een wetenschappelijk doel. Het staat open voor alle wetenschappelijke bijdragen zonder ideologisch of dogmatisch streven.

De wetenschappelijke inhoud van het tijdschrift wordt bewaakt door een permanente redactieraad en een internationaal leescomité dat is samengesteld in functie van het thema van de individuele bijdrage. Deze raad en comité hebben in geen geval het recht om de manuscripten te censureren, behalve bij manifest gebrek aan wetenschappelijke ernst. De auteurs zijn steeds de enige verantwoordelijken voor de inhoud van hun bijdrage.

Société royale belge d'Anthropologie et de Préhistoire

a.s.b.l.

Rue Vautier, 29
B-1000 Bruxelles

Koninklijke Belgische Vereniging voor Antropologie en Prehistorie

v.z.w.

Vautierstraat, 29
B-1000 Brussel

Fondée en 1882, la Société d'Anthropologie de Bruxelles est devenue la Société royale belge d'Anthropologie et de Préhistoire à partir de 1931. Elle réunit des chercheurs professionnels ou non, belges et étrangers, spécialistes en archéologie préhistorique, en anthropologie physique, en anthropologie génétique ou en paléontologie humaine.

De Vereniging voor Antropologie van Brussel, gesticht in 1882, kreeg vanaf 1931 de benaming van Koninklijke Belgische Vereniging voor Antropologie en Prehistorie. Ze verenigt al dan niet professionele onderzoekers, zowel Belgische en buitenlandse, gespecialiseerd in de prehistorische archeologie, in de fysische antropologie, in de genetische antropologie of in de menselijke paleontologie.

Bureau 2012-2013

Présidente
Vice-présidents
Secrétaire générale
Trésorier
Bibliothécaire

Nathalie VANMUYLDER
Rosine ORBAN, Bart VANMONFORT, Damien FLAS
Caroline POLET
Denise VANDEMEULEBROUCKE
Ivan JADIN

Voorzitster
Ondervoorzitters
Secretaris-generaal
Schatbewaarder
Bibliothecaris

+32 2 627 41 45

srbap@naturalsciences.be

Compte bancaire
Bankrekening
BE46 0000 3074 2936

ISSN 1377-5723

SPY CAVE

125 years of multidisciplinary research
at the Betche aux Rotches
(Jemeppe-sur-Sambre, Province of Namur, Belgium)

Edited by Hélène ROUGIER & Patrick SEMAL

Volume 1

2013

TABLE OF CONTENTS

Camille PISANI, Foreword	5
--------------------------------	---

INTRODUCTION

I. Patrick SEMAL, Hélène ROUGIER, Isabelle CREVECOEUR, Damien FLAS, Anne HAUZEUR & Cécile JUNGELS, Prologue	9
II. Patrick SEMAL, Anne HAUZEUR, Michel TOUSSAINT, Cécile JUNGELS, Stéphane PIRSON, Laurence CAMMAERT & Philippe PIRSON, History of excavations, discoveries and collections	13
III. Philippe PIRSON, Spy cave: which name?	41
IV. Laurence CAMMAERT, Through the correspondence: the little story of the “Spy bones”	55

THE SPY CAVE CONTEXT

V. Stéphane PIRSON, Bernard DELCAMBRE & Éric GOEMAERE, Geological context	73
VI. Stéphane PIRSON, Kévin DI MODICA, Cécile JUNGELS, Damien FLAS, Anne HAUZEUR, Michel TOUSSAINT & Patrick SEMAL, The stratigraphy of Spy cave. A review of the available lithostratigraphic and archaeostratigraphic information	91

ARCHAEOLOGICAL MATERIAL

VII. Anne HAUZEUR, Cécile JUNGELS, Éric GOEMAERE & Stéphane PIRSON, Non-flint raw materials	135
VIII. Éric GOEMAERE, Cécile JUNGELS & Anne HAUZEUR, Oolithic ironstones from Spy cave	151
IX. Kévin DI MODICA, Cécile JUNGELS & Anne HAUZEUR, What do we know today about the Middle Palaeolithic of Spy?	167
X. Cécile JUNGELS, Aude COUDENNEAU, Anne HAUZEUR & Philippe PIRSON, Typological, technological and functional analyses of Mousterian points	201
XI. Damien FLAS, Jerzmanowice points from Spy and the issue of the Lincombian-Ranisian-Jerzmanowician	217
XII. Damien FLAS, Elise TARTAR, Jean-Guillaume BORDES, Foni LE BRUN-RICALENS & Nicolas ZWYNS, New perspectives on the Aurignacian from Spy: lithic assemblage, osseous artefacts and chronocultural sequence	231
XIII. Damien PESESSE & Damien FLAS, Which Gravettians at Spy?	257
XIV. Gennady A. KHLOPACHEV, Cultural and chronological attribution of the objects of mammoth ivory from Spy cave: a look from Eastern Europe	269

FAUNAL REMAINS

XV. Mietje GERMONPRÉ, Mircea UDRESCU & Evelyne FIERES, The fossil mammals of Spy	289
--	-----

BIOGEOCHEMISTRY

XVI. Patrick SEMAL, Anne HAUZEUR, Hélène ROUGIER, Isabelle CREVECOEUR, Mietje GERMONPRÉ, Stéphane PIRSON, Paul HAESAERTS, Cécile JUNGELS, Damien FLAS, Michel TOUSSAINT, Bruno MAUREILLE, Hervé BOCHERENS, Thomas HIGHAM & Johannes VAN DER PLICHT, Radiocarbon dating of human remains and associated archaeological material	331
XVII. Hervé BOCHERENS, Mietje GERMONPRÉ, Michel TOUSSAINT & Patrick SEMAL, Stable isotopes	357
XVIII. Eva-Maria GEIGL, Sophie CHAMPLLOT, Silvia DE LIMA GUIMARAES, E. Andrew BENNETT & Thierry GRANGE, Molecular taphonomy of Spy: DNA preservation in bone remains	371
Guide for authors	381



BIOGEOCHEMISTRY

Patrick SEMAL, Anne HAUZEUR & H el ene ROUGIER
(Coordinators)

CHAPTER XVI

SEMAL P., HAUZEUR A., ROUGIER H., CREVECOEUR I., GERMONPRÉ M., PIRSON S., HAESAERTS P., JUNGELS C., FLAS D., TOUSSAINT M., MAUREILLE B., BOCHERENS H., HIGHAM T. & VAN DER PLICHT J., 2013.

Radiocarbon dating of human remains and associated archaeological material: 331-356.

CHAPTER XVII

BOCHERENS H., GERMONPRÉ M., TOUSSAINT M. & SEMAL P., 2013.

Stable isotopes: 357-370.

CHAPTER XVIII

GEIGL E.-M., CHAMPLOT S., DE LIMA GUIMARAES S., BENNETT E. A. & GRANGE T., 2013.

Molecular taphonomy of Spy: DNA preservation in bone remains: 371-380.

In: H. ROUGIER & P. SEMAL (ed.), Spy cave. 125 years of multidisciplinary research at the Betche aux Rotches (Jemeppe-sur-Sambre, Province of Namur, Belgium), Volume I. Anthropologica et Præhistorica, 123/2012. Brussels, Royal Belgian Institute of Natural Sciences, Royal Belgian Society of Anthropology and Præhistory & NESPOS Society.

Supporting information available at:

<http://mars.naturalsciences.be/bibliop4plone/rbins-publications/spy-cave-volume-1/supporting-information/>

CHAPTER XVI

RADIOCARBON DATING OF HUMAN REMAINS AND ASSOCIATED ARCHAEOLOGICAL MATERIAL

Patrick SEMAL, Anne HAUZEUR, Hélène ROUGIER, Isabelle CREVECOEUR, Mietje GERMONPRÉ, Stéphane PIRSON, Paul HAESAERTS, Cécile JUNGELS, Damien FLAS, Michel TOUSSAINT, Bruno MAUREILLE, Hervé BOCHERENS, Thomas HIGHAM & Johannes VAN DER PLICHT

Abstract

The Neandertal skeletal material from Spy cave has finally been directly dated by AMS ^{14}C one hundred twenty-five years following their discovery. Fifteen human bones and teeth were dated in order to verify new morphological analyses and determine the age of the Spy Neandertals. Collagen from 14 faunal remains and three bone or ivory artefacts were also dated in order to establish a radiocarbon framework for the three “fauna-bearing levels” defined by the original excavators. Apart from several dates that are clearly too young due to contamination or diagenetic influences, our results show that the three oldest dates (ca. 36,000 uncal BP) for the two Neandertal adults are reliable given that the quality parameters are within the accepted confidence interval. We discuss the results of these new dates and their significance in light of the site’s stratigraphy, the local Belgian context, and the wider European framework. Radiocarbon dating of Neolithic human skeletal material is also presented and discussed.

INTRODUCTION

The precise chronology and palaeoenvironmental backdrop of the majority of Neandertal remains recovered across Europe remain largely unknown, mainly due to insufficient contextual information and related archaeological data recorded during late 19th or early 20th century excavations. Unfortunately, several more recent excavations also lack a certain degree of precision given the rarity of detailed stratigraphic information coupled with a poor understanding of the nature and importance of taphonomic processes. The latter are tied to complex sedimentary dynamics and sediment diagenesis especially prevalent in cave entrances where most of the Neandertal remains have thus far been recovered and where sedimentary sequences are often compacted and discontinuous (Ferrier, 2002; Texier *et al.*, 2004; Goldberg & Sherwood, 2006; Pirson, 2007). The occupation chronology of particular sites is therefore difficult to establish with any certainty and remains largely dependent on radiocarbon dates.

In the case of Spy, the presence of anatomically modern human (AMH) skeletal material mixed with Neandertal elements cannot be

excluded given the scarcity of information concerning the original fieldwork. Furthermore, like many other caves in the Meuse Valley, the site served as a collective burial ground throughout prehistory, particularly during the Middle and Late Neolithic. Therefore, new radiocarbon dates not only establish the age of the AMH remains, but provide a crucial chronological control for certain anthropological interpretations.

Neandertal skeletal material from only a handful of other sites has been directly dated by ^{14}C including those from Feldhofer, Vindija, El Sidrón, Okladnikov, Mezmaiskaya, Les Rochers-de-Villeneuve, Engis and Spy, all of which have been attributed to the period between ca. 45,000 and 30,000 BP (Ovchinnikov, 2000; Schmitz *et al.*, 2002; Serre *et al.*, 2004; Beauval *et al.*, 2005; Higham *et al.*, 2006; Rosas *et al.*, 2006; Toussaint & Pirson, 2006; Krause *et al.*, 2007; Semal *et al.*, 2009; De Torres *et al.*, 2010; Pinhasi *et al.*, 2011). More recently, the mandible from Cova del Gegant near Barcelona, Spain, was directly dated using a new U-series technique (Daura *et al.*, 2010) that may offer further opportunities to date Neandertal skeletal material beyond the limits of ^{14}C , however more testing is required to confirm its reliability.

Nevertheless, recent reassessments suggest that a number of these direct dates are probably only minimum ages due to contamination and/or the collagen extraction protocols employed (Smith *et al.*, 1999; Higham *et al.*, 2006; Pinhasi *et al.*, 2011). Discrepancies of several millennia exist between Neandertal skeletal material from the same site (Rosas *et al.*, 2006) as well as between samples from the same bone (Krause *et al.*, 2007). Moreover, inconsistencies between dates produced from archaeological material and those obtained from associated human bones may invalidate the youngest ages as appears to be the case, for example, at Mezmaiskaya in Russia (Skinner *et al.*, 2005; Toussaint & Pirson, 2006).

DIRECT DATING OF HUMAN REMAINS FROM SPY

Previous direct dating attempts

The first attempt to directly date human remains from Spy was carried out by P. Semal (Semal *et al.*, 1996) on an AMH frontal bone from the Spy IV individual discovered in 1952 by F. Twisselmann from slope deposits between the cave's terrace and the Orneau River. The first date was obtained from a sample with a very low collagen yield (OxA-6112; see Table 1). However, a second attempt (OxA-6252) corroborated the first date, thus confirming the piece in question to be of Neolithic age. Furthermore, the fact that the specimen was found lying on the bedrock in a layer rich in Upper Palaeolithic artefacts clearly demonstrates the stratigraphy of the slope deposits to be reworked.

The first attempt to directly date the Neandertal remains from Spy was carried out by M. Toussaint (Toussaint & Pirson, 2006) on a sample from a right scapula (Spy 572a) housed at the *Université de Liège* (ULg). This fragmentary scapula, attributed to Spy II since its discovery (Fraipont & Lohest, 1886), presents at least one diagnostic Neandertal feature (a dorsal sulcus along the axillary border; Trinkaus, 2006; Toussaint *et al.*, volume 2: chapter XXVIII-1). The first date produced by the Oxford Radiocarbon Accelerator Unit (ORAU) was too young (< 25,000 BP), significantly more recent than the one provided by the Centre for Isotope Research

(CIO) at the University of Groningen using a collagen sample extracted by H. Bocherens from the same bone (Table 1). At the time, the pretreatment method used by the ORAU was essentially the same as that of the CIO, making it difficult to determine why the results diverged. It is possible that these discrepancies relate to the differential consolidation and decontamination of the sampled bone. The likely contamination of the scapula during 19th century consolidation efforts, possibly with glue containing animal bone collagen, is made clear in historical sources (see Geigl *et al.*, this volume: chapter XVIII). This probability is further supported by the second, slightly older age obtained by the ORAU (OxA-8913) following the application of a solvent extraction procedure prior to bone pretreatment. This possible slight contamination by modern collagen was not detected in the analysis performed by H. Bocherens.

Finally, a fragment of a human vertebra (Spy 737a) discovered in 2002 on the surface of the slope deposits connecting the cave's terrace and the Orneau River was directly dated to $36,250 \pm 500$ ^{14}C BP at the ORAU using an ultra-filtration protocol (Toussaint & Pirson, 2006; Table 1). Despite Spy 737a not being clearly associated with the original Neandertal skeletal material discovered in 1886 (see Toussaint *et al.*, volume 2: chapter XXVIII-3), the quality parameters indicate the date to be reliable (i.e. collagen yield and C:N ratios within the accepted range, see below), supporting the late survival of the Spy Neandertals.

New direct dating attempts

Recent re-examination of the unsorted faunal collections from Spy identified numerous hitherto unpublished Neandertal and AMH remains. These new, untreated specimens, unlike those from the original 1886 collection contaminated by varnish, were suitable for direct AMS radiocarbon dating. Samples were selected in order to verify the conclusions of the morphometric study (Cowgill, volume 2: chapter XX-1; Crevecoeur *et al.*, volume 2: chapter XX-2; Rougier *et al.*, volume 2: chapter XIX) and address the following questions:

- What is the radiocarbon age of the two Neandertal adults (Spy I and Spy II)?

Lab number	¹⁴ C date (BP)	Age (BP) 95 % probability	Calibrated age (cal BP) 95 % probability	Specimen	Presumed taxon	Description	Material
OxA-8912 (1)	23,880 +240/-240	24,360 – 23,400	29,350 – 28,110	Spy 572a	Neandertal	Fragment of a right scapula	bone
OxA-8913 (1)	24,730 +240/-240	25,210 – 24,250	30,280 – 29,000				
GrA-21546 (1)	31,810 +250/-250	32,310 – 31,310	36,840 – 35,370				
OxA-10560 (UF) (1)	36,250 +500/-500	37,250 – 35,250	42,160 – 40,440	Spy 737a	Neandertal?	Vertebral fragment	bone
OxA-6112 (2)	4,025 +55/-55	4,135 – 3,915	-2,860 – -2,350 (BC)	Spy 569a	AMH	Facial skeleton (Spy IV)	bone
OxA-6252 (2)	4,230 +70/-70	4,370 – 4,090	-3,010 – -2,585 (BC)				

Table 1. Previous direct dates obtained on human remains from Spy.

(1) Original data from Toussaint & Pirson (2006); (2) Original data from Semal *et al.* (1996).

Calibration using OxCal 4.1 (Interface build: 54; Bronk Ramsey, 1994) and IntCal09 curve. UF: Ultrafiltration.

- Are there AMH remains among the original 1886 collection and, if so, how old are they?
- What is the radiocarbon age of the Spy III child tibia from the original collection published by Twiesselmann (1953) as Neandertal?
- What is the radiocarbon age of the newly identified Neandertal child Spy VI?
- What is the radiocarbon age of the newly identified human specimens displaying features that fall within the known range of Neandertal morphometric variability?

DATING OF THE ARCHAEOLOGICAL AND FAUNAL MATERIAL

Archaeological context

The nature of the late 19th century excavations renders the archaeological context of the Neandertal individuals far from certain (Semal *et al.*, this volume: chapter II). The only secure contextual element is the presence of several different Middle and Upper Palaeolithic occupations illustrated by mixed material in several layers defined by the original excavators (Pirson *et al.*, this volume: chapter VI).

The original excavators identified three “fauna-bearing levels” (FBLs) with the two Neandertal individuals recovered from the deepest level (third FBL) between a layer of “brown clay” overlying the bedrock and a thin layer of “yellow clay” (Fraipont & Lohest, 1886; De Puydt & Lohest, 1887). The hard, reddish breccia of the second FBL situated just above the skeletons was used to support the absence of mixing

between the deposits. The original stratigraphy was subsequently replaced by a “cultural stratigraphy” based on tool typology. Breuil (1912) recognised four cultural levels, dividing the Middle Palaeolithic assemblage into two different Mousterian industries and associating the Neandertal remains with the Upper Mousterian level (second FBL). These new stratigraphic divisions introduced an additional source of inconsistencies, further mixing the material. Much later, F. Bordes (1959) identified a Quina Mousterian based on the presence of certain typical Quina-type tools. Moreover, he suggested that the human fossils may be associated with this techno-complex based solely on comparisons with other sites having produced Neandertal burials.

In the second FBL, Ulrix-Closset (1975) recognised a Late Mousterian assemblage, a transitional industry known as the Lincombian-Ranisian-Jerzmanowician or LRJ (Campbell, 1980; Flas, 2006), and a significant quantity of Aurignacian material (Otte, 1979). A recent re-analysis of the lithic material from Spy has provided a detailed revision of the archaeological sequence, integrating current questions surrounding the so-called “transitional lithic techno-complexes” and the Aurignacian (Flas, 2008, this volume: chapter XI; Flas *et al.*, this volume: chapter XII).

Previous dating attempts

Only two conventional radiocarbon dates were previously obtained on bone samples from the 1909 de Loë and Rahir excavations (Table 2) submitted by M. Otte to the *Institut Royal du Patrimoine Artistique* (IRPA-202 and IRPA-203;

Dauchot-Dehon & Heylen, 1979). The bones did not yield sufficient collagen for ^{14}C dating, instead the carbonate fraction was used – a practice not uncommon in the early days of radiocarbon dating. Only later was it realised that carbonates often yield unreliable dates due to chemical exchanges with the depositional environment (Olsson, 2009). Furthermore, this was well before the introduction of the AMS ^{14}C technique enabling the dating of small, valuable samples. The IRPA carbonate dates are too young and provide only minimal ages for the first (upper) and second FBL.

MATERIALS AND METHODS

Sample preparation

The selected human specimens were scanned or μ -scanned (Semal *et al.*, 2005) and then cast by Eric Dewamme (RBINS) using a silicone elastomer (Dow Corning DC 3481). High-resolution digital photographs were taken before and after sampling with a Olympus E-10 or Nikon Coolpix 4500 depending on the size of the sample. All data related to the samples and 3D models (CT and surface) are stored in the MARS

Lab number	^{14}C date (BP)	Age (BP) 95 % probability	Calibrated age (cal BP) 95 % probability	Specimen	Taxon	Description (after Dauchot-Dehon & Heylen, 1979)	Material
IRPA-202	20,680 +450/-450	21,580 – 19,780	25,990 – 23,670	de Loë 1909	Fauna	Upper level: Perigordian	bone
IRPA-203	25,300 +510/-510	26,320 – 24,280	31,080 – 29,280	de Loë 1909	Fauna	Intermediate level: Early Aurignacian	bone

Table 2. Previous direct dates obtained on faunal remains from Spy. Original data from Dauchot-Dehon & Heylen (1979). Calibration using OxCal 4.1 (Interface build: 54; Bronk Ramsey, 1994) and IntCal09 curve.

Current dating attempts

The discovery among the RBINS faunal collections of new, unvarnished human remains provided the opportunity to obtain new AMS radiocarbon dates. Moreover, an assessment of the still mostly unpublished, but labelled faunal material allowed the original stratigraphic position of some of the remains to be determined. In several cases, the presence of human modifications such as traces of ochre and/or cutmarks was used to help identify the stratigraphic position of the artefacts (Germonpré *et al.*, this volume: chapter XV).

Faunal and osseous artefacts were sampled and dated with the aim of:

- Establishing a ^{14}C chronology for the three “fauna-bearing levels” constituting De Puydt & Lohest (1887) original stratigraphy;
- Addressing specific issues such as the chronology of the Aurignacian occupation from the second FBL;
- Evaluating the ^{14}C chronology of the “red layer” containing elements of at least 3 different techno-complexes (Mousterian, LRJ, and Aurignacian).

(Semal *et al.*, 2004; <http://mars.naturalsciences.be>) and NESPOS (Gröning *et al.*, 2007; www.nespos.org) databases, respectively. Digital photos of the bone artefacts and faunal remains were taken before and after sampling using a Nikon Coolpix 4500. Data related to these samples are also available in the MARS database. Photos of all specimens were submitted with the CIO and ORAU forms in order to delimit the preferred sampling areas.

The bones and teeth submitted to the CIO were first sampled using a Dremel rotating mini-saw as illustrated in Figure 1. The surface of the samples was subsequently cleaned and the internal portion used for collagen extraction. At the ORAU, the specimens were directly sampled with a high-power, low-speed mini-drill with collagen extracted from the resulting powder.

Collagen extraction and radiocarbon dating protocols

The CIO operates both conventional (until 2012) and AMS facilities for large (several grams) and small (milligrams) sample sizes, respectively. Dating the Spy material was only

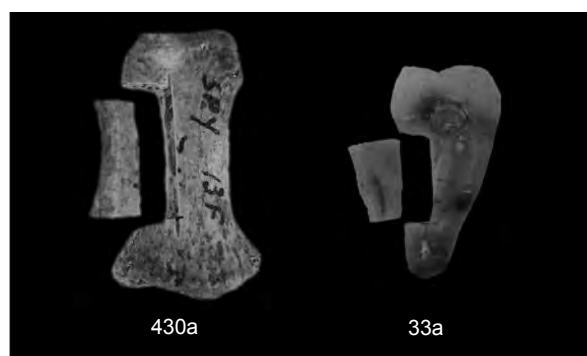

Figure 1. Examples of bone and tooth sampling at the CIO (left: Spy 430a, a Neandertal third middle manual phalanx; right: Spy 33a, a lower right second premolar). The bone and tooth root are cut using a small saw and the surface is removed. The remaining sample is used for demineralisation.

possible using small samples and thus required the AMS method. At the CIO, bone collagen extraction follows a procedure developed by Longin (1970) for the standard chemical pretreatment of samples (Mook & Streurman, 1983). Bone mineral is dissolved by repeated treatment with an acid solution (1-2 % HCl) over several days with 10-20 % of the bone collagen dissolved in the process. The raw collagen containing the carbonaceous contaminants is thoroughly washed with demineralised water before being treated with slightly acidic demineralised water. During this treatment, “pure” collagen dissolves into gelatine, insoluble material is removed by centrifuge, and the gelatine is collected by evaporation. The ultra-filtrated samples dated at the ORAU were prepared following the protocol described by Higham *et al.* (2006).

The main difficulty encountered when dating collagen is chemical and/or bacterial degradation resulting from compounds that easily combine with carbonaceous substances present in the surrounding environment. In extreme cases, the collagen may disappear completely. Three parameters are employed to assess the quality of the extracted collagen (and thus the reliability of the ^{14}C date): the yield, carbon content, and stable carbon isotope ratio $\delta^{13}\text{C}$. The C:N ratio is also used as an additional indicator. Fresh bone contains about 20 % collagen by weight, with a carbon content of ca. 50 %. In general, acceptable results for prehistoric bone can be expected when the collagen yield is

greater than 1 %, and the carbon content of the collagen is greater than 35 %. The $\delta^{13}\text{C}$ values should generally range between -19 to -22 ‰; however, these values can be influenced by dietary effects linked to varying photosynthetic carbon metabolisms between different plants as well as the position of the organism in the food chain (Van der Merwe & Vogel, 1978; Lanting & van der Plicht, 1998; Bocherens *et al.*, 2001). The collagen is combusted, purified and transformed into graphite (e.g. Aerts *et al.*, 2001) which is then pressed into target holders for the AMS ion source which measures the $^{14}\text{C}/^{12}\text{C}$ and $^{13}\text{C}/^{12}\text{C}$ ratios from which the conventional ^{14}C age (CRA; Stuiver & Polach, 1977) is determined (van der Plicht *et al.*, 2000).

Calibration

Shortly after the invention of radiocarbon dating, changes in the strength of the geomagnetic field (Bucha, 1970) and variations in solar activity (de Vries, 1958; Stuiver, 1965) were shown to effect the ^{14}C concentration in atmospheric CO_2 . These variations in the natural ^{14}C concentration mean that the ^{14}C clock runs at a pace that differs from real clocks, in other words, radiocarbon years are not directly analogous to calendar years. Additionally, complications arose from isotope fractionation effects and uncertainties in the half-life value. Therefore, a special convention has been agreed between ^{14}C laboratories – conventional dates are reported according to an internationally agreed half-life and corrected for fractionation effects using the sample’s ^{13}C content. These conventional dates are reported as “BP”. For archaeology, this means that the ^{14}C timescale is *fixed* and has to be *calibrated* in order to express the radiocarbon age as a calendar date.

Traditionally, radiocarbon dates are calibrated using calibration curves based on wood samples dated by both ^{14}C and dendrochronology. However, this is only possible for samples younger than ca. 12,500 years as a corroborating dendrochronology is unavailable thereafter. Beyond this point, calibration curves are largely based on marine records. The most commonly employed calibration curve is IntCal09 that has recently provided the first calibration for the complete ^{14}C dating range reaching to 50 ky

(Reimer *et al.*, 2009). This marine-based curve nonetheless has large uncertainties connected to unknown reservoir effects. Recently available records, most notably a laminated, terrestrial sedimentary sequence from Lake Suigetsu, Japan, have provided significant refinements (Bronk Ramsey *et al.*, 2012; Reimer, 2012) that will shortly be incorporated in a revised version of the calibration program, IntCal13 (Reimer *et al.*, 2013). The Spy dates discussed in this chapter, shown in SF1 with uncertainties plotted at 1 sigma, were calibrated using the IntCal09 curve and OxCal version 4.1 (Bronk Ramsey, 1994).

RESULTS AND COMMENTS

Human material

AMH remains from the original Spy collection

Five human remains either previously identified from the original Lohest collection as supposedly Neandertal or recently discovered amongst the faunal material from Twisselman's excavations all date to the Neolithic (Table 3;

Figure 2). The first, Spy 425k, is a fragment of a right fibular diaphysis that refits with Spy 26A from the original Lohest collection attributed to the Spy II Neandertal by Hrdlička (1930; see SF2). However, a date of $4,350 \pm 35$ BP¹ (GrA-32621) places this fragment squarely in the Neolithic.

The second, Spy 398l, is a right third metacarpal (MTC) that articulates with the MTC 2 (Spy 22B) from the 1886 collection. Spy 22B presumably belongs to a set of MTC that Fraipont & Lohest (1886) attributed to the Spy I/II individual. However, its distal end has a metaphyseal surface. The two MTC thus represent an immature individual that cannot be either Spy I or II. Furthermore, the direct date for Spy 398l of $4,800 \pm 40$ BP (GrA-32628) clearly shows that neither represents an additional Neandertal individual (SF3).

A right phalanx (Spy 425n) matching the proximal left hallucal phalanx (Spy 25G) attrib-

¹ BP: conventional ¹⁴C dates (see text); BC, cal BP: calendar dates, with cal BP = 1,950 + BC.

Lab number	¹⁴ C date (BP)	Age (BP) 95 % probability	Calibrated age (cal BP) 95 % probability	Specimen	Presumed taxon	Description	Material
OxA-20981 (UF)	3,896 +35/-35	3,966 – 3,826	-2,475 – -2,245 (BC)	Spy 7A	AMH?	Left ulna, proximal frag.	bone
GrA-32621	4,350 +35/-35	4,420 – 4,280	-3,090 – -2,900 (BC)	Spy 425k	AMH?	Right fibula diaphysis frag.	bone
GrA-44542	4,710 +35/-35	4,780 – 4,640	-3,630 – -3,375 (BC)	Spy 26C	AMH?	Juvenile tibia diaphysis (Spy III)	bone
GrA-32628	4,800 +40/-40	4,880 – 4,720	-3,660 – -3,385 (BC)	Spy 398l	AMH?	Juvenile right third metacarpal	bone
GrA-32632	4,835 +35/-35	4,905 – 4,765	-3,700 – -3,530 (BC)	Spy 425n	AMH?	Right proximal hallucal phalanx	bone
GrA-44543	4,085 +35/-35	4,155 – 4,015	-2,860 – -2,495 (BC)	Spy 336a	Neandertal?	Right radius diaphysis frag.	bone
GrA-32622	4,600 +35/-35	4,670 – 4,530	-3,510 – -3,125 (BC)	Spy 33a	Neandertal?	Lower right P4	dentine
GrA-32625	4,635 +35/-35	4,705 – 4,565	-3,520 – -3,350 (BC)	Spy 432a	Neandertal?	Juvenile right parietal frag.	bone
GrA-32623	35,810 +260/-240	36,330 – 35,330	41,570 – 40,410	Spy 94a	Neandertal	Right maxilla frag. attached to M3 (Spy I)	compact bone
GrA-32626	36,350 +310/-280	36,970 – 35,790	42,000 – 40,940	Spy 92b	Neandertal	Upper left I1 (Spy II)	dentine
GrA-32630	33,940 +220/-210	34,380 – 33,520	39,600 – 38,000	Spy 430a	Neandertal	Right middle 3rd manual phalanx (Spy II)	thin compact bone
OxA-17916 (UF)	32,550 +400/-400	33,350 – 31,750	38,480 – 36,470				
GrA-32627	32,970 +200/-190	33,370 – 32,590	38,490 – 36,870	Spy 646a	Neandertal	Right hemi-mandible (Spy VI)	thin compact bone
OxA-17977 (UF)	34,700 +550/-550	35,800 – 33,600	41,070 – 38,670	Spy 589a	Neandertal	Upper right di1 (Spy VI)	dentine
OxA-21610 (UF)	33,950 +550/-550	35,050 – 32,850	40,490 – 37,300				

Table 3. New direct dates obtained on human remains from Spy. Calibration using Oxcal 4.1 (Interface build: 54; Bronk Ramsey, 1994) and IntCal09 curve. UF: Ultrafiltration.

uted to one of the two adult Neandertals by Twiesselmann (1971) was also discovered amongst the Spy fauna. However, the date obtained ($4,835 \pm 35$ BP; GrA-32632) conclusively demonstrates that neither of the two pedal phalanges are Neandertal (SF4).

The juvenile tibial diaphysis, Spy 26C, forms part of the original collection and was attributed by Twiesselmann (1971) to the Spy III individual. However, the anthropological study of this specimen (see Cowgill, volume 2: chapter XX-1) concluded that it is probably AMH. This was subsequently confirmed by a direct AMS radiocarbon date ($4,710 \pm 35$ BP; GrA-44542; SF5). Although the bone was varnished, the protocol used at the CIO removed all the bone's surface before sampling therefore rendering the extracted collagen free of surface varnish traces.

Finally, the Spy 7A left ulnar fragment from the original collection was dated, despite the risk of contamination due to glue and/or varnish, as a recent morphometric study cast doubts concerning its Neandertal affinities (Hambücker,

volume 2: chapter XXVI-1). The direct date for Spy 7A shows that it is indeed of Neolithic age ($3,896 \pm 35$ BP; OxA-20981; SF6).

Human remains with ambiguous characteristics

Three new specimens were selected from the newly identified human remains based on their morphology and/or morphometry being compatible with a Neandertal attribution (Table 3; Figure 3). The Spy 336a radius was selected by Anne Hambücker for dating as her study of the upper limb bones suggested it portrayed some possible Neandertal features (Hambücker, volume 2: chapter XXVI-1). The Spy 33a lower right second premolar was also selected as its crown dimensions fall outside the variability of recent AMH coupled with the presence of several archaic features such as an enamel pearl on the distal face of the root (Figure 3). However, both specimens returned Neolithic ages ($4,085 \pm 35$ BP; GrA-44543; SF7 and $4,600 \pm 35$ BP; GrA-32622; SF8, respectively), thus ruling out the possibility that they represent new Neandertal skeletal material.



Figure 2. AMH remains from Spy directly dated to the Neolithic. Spy 398I-604a and 22B (right third and second metacarpals with Spy 604a being the distal epiphysis of MTC Spy 398I) in palmar and proximal views; plantar and proximal views of Spy 425n and 25G (right and left first proximal pedal phalanges); anterior view of Spy 26A & 425k (right fibular diaphysis fragments); lateral view of Spy 7A (left ulna from the 1886 collection identified as AMH by Anne Hambücker); anterior view of Spy 26C (tibia diaphysis fragment of the Spy III juvenile). Specimens from the original collection are indicated in italics; newly discovered ones are in plain font. Scales = 1 cm.

Finally, Spy 432a is a small right parietal fragment that refits with a fragmentary juvenile rear cranium showing a slight depression and transverse torus in the inferior part of the occipital plane. Although a possible Neandertal attribution was suspected, radiocarbon dating once again demonstrated the specimen to be Neolithic ($4,635 \pm 35$ BP; GrA-32625; SF9). Interestingly, Spy 432a is one of two parietal fragments of the juvenile cranium recovered by F. Twiesselmann in the 1950s, whereas the other fragments come from the 1903 excavations of de Loë and Rahir.

The Neolithic specimens

The nine ^{14}C dates for the Spy Neolithic specimens represent the largest sample ever obtained in Belgium for a Neolithic sepulchral cave. The distribution of the different calibrated

dates suggests the site functioned as a burial ground over more than twelve centuries (Figure 4). Unfortunately, the poor quality of the early excavations precludes knowing whether different burial phases were observable. Even today, discerning between extended and brief periods of use is not simple. Moreover, it is impossible to decipher how and why Neolithic bones became “collected” with the Neandertal remains and eventually included in the original Lohest collection despite several metres of sediments separating deposits containing the two different groups of human remains.

Nevertheless, the various radiocarbon dates suggest at least two burial phases; the first corresponding to the end of the Middle Neolithic, around 3,500 BC, represented by five dates from three immature specimens (MNI = 1), one sub-adult and one adult. This first group differs sig-

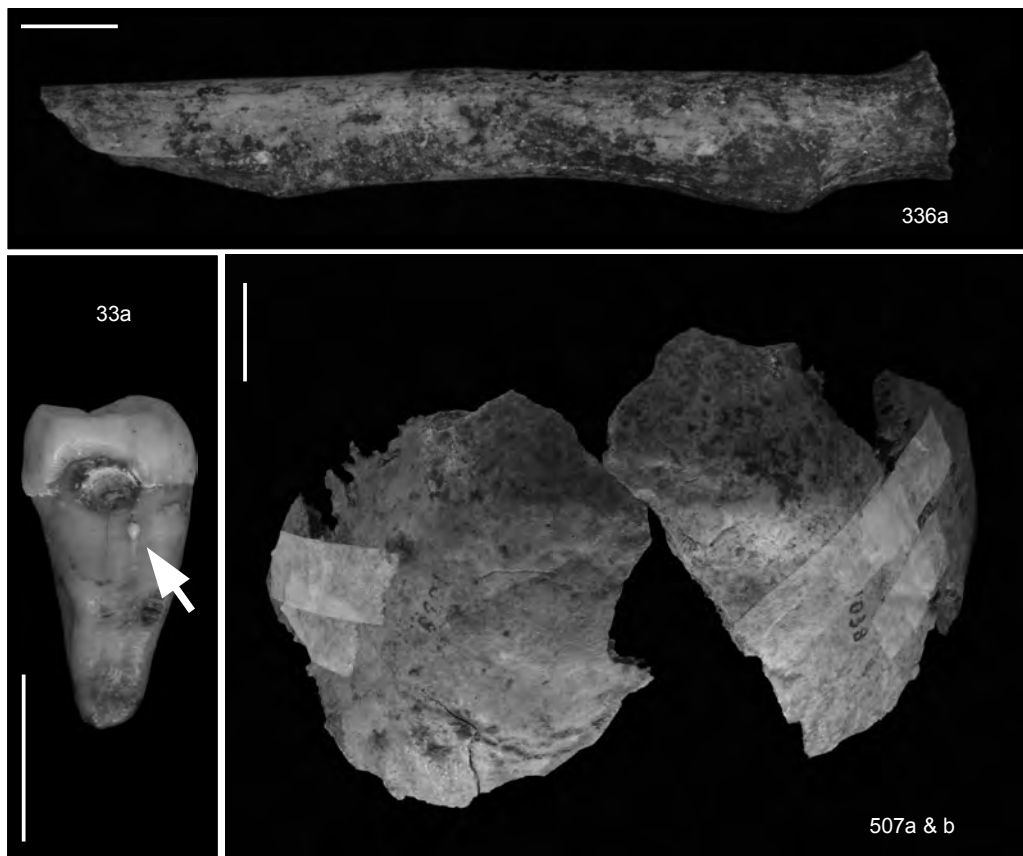

Figure 3. AMH from Spy with ambiguous features directly dated to the Neolithic. Anterior view of Spy 336a (right radius fragment isolated by Anne Hambücker); distal view of Spy 33a (lower right second premolar with a cavity and enamel pearl [arrow]); posterior view of Spy 507a and 507b (occipital portion of a juvenile calvaria with a small supra-iniac depression). Scales = 1 cm.

nificantly from a second set of four dates ranging between 3,000 BC and 2,400 BC. The youngest date is from the Spy 7A ulna and probably represents a minimum age due to possible contamination of the original collection by modern animal collagen (glue) as already suspected for the Neandertal scapula (Spy 573a). The three remaining dates all belong to the Late Neolithic. The fibula fragment that refits with the Spy 26A specimen is dated to about 3,000 BC, while dates obtained on the Spy IV cranium and the Spy 336a radius are situated in a plateau of the calibration curve (Figure 4).

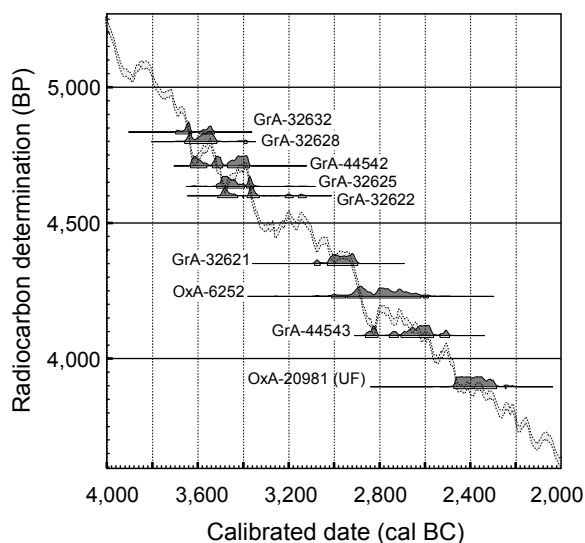

Figure 4. Calibrated dates (cal BC) for the Spy AMH specimens dated to the Middle and Late Neolithic projected on the calibration curve using OxCal 4.1 (Interface build: 54; Bronk Ramsey, 1994).

Up until now, sixty-four collective burial sites from the Meuse Basin (including Spy) have been dated by 98 radiocarbon determinations (Toussaint, 2007) of which 24 belong to the Middle Neolithic and 74 to the Late Neolithic. Only three sites date to both the Middle and Late Neolithic: Grotte de la Cave (Maurenne, Hastière, prov. of Namur), Grotte CH1 de Chauveau (Godinne, Yvoir, prov. of Namur) and Grotte de La Préalée II (Heyd, Durbuy, prov. of Luxembourg). These new dates add Spy to the list of Middle and Late Neolithic burial sites. However, it is important to note that only a single radiocarbon date is available for most sites and we cannot exclude the possibility that the actual number of sites containing both Middle and Late Neolithic burials is underestimated due to sampling bias.

Neandertal adults: Spy I and Spy II

Individual teeth belonging to each of the dental sets found amongst the unpublished material collected during the RBINS excavation allowed both adult Neandertals from Spy to be directly dated (Figure 5). These two teeth, an upper right M3 (Spy 94a) identified by P. Semal and B. Maureille, and an upper left I1 (Spy 92b) identified in the unsorted faunal material from the same excavation by H. Rougier, produced radiocarbon dates that cluster around 36,000 ^{14}C BP (Table 3; $35,810 \pm 260$ BP, GrA-32623, SF10; $36,350 +310/-280$ BP, GrA-32626, SF11).

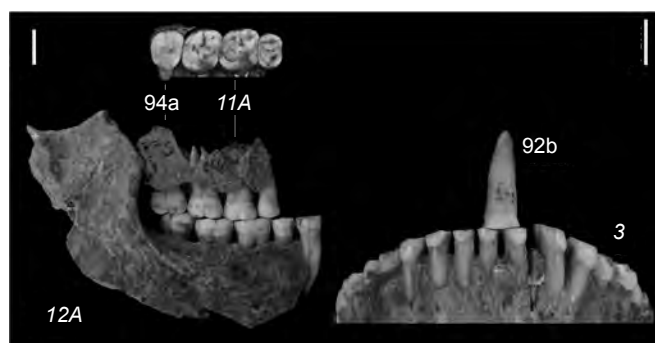

Figure 5. Neandertal remains attributed to Spy I and II directly dated by Semal *et al.* (2009). Left: Spy 94a, an upper right third molar retaining a small alveolar fragment that refits with the Spy 11A maxilla fragment; right: Spy 92b, an upper left central incisor that articulates with the lower incisors of the Spy 3 mandible. Specimens from the original collection are indicated in italics; newly discovered ones are in plain font. Scales = 1 cm.

A final, newly dated adult specimen represented by a third middle hand phalanx (Spy 430a) was recently identified by I. Crevecoeur from the Spy faunal collection. The morphometric characteristics of this specimen are fully Neandertal (Crevecoeur, volume 2: chapter XXVII; Figure 6). In total, ten new Neandertal hand bones have been discovered amongst the faunal remains. Most belong to the same individual, helping determine that Spy 430a is actually an MP 3 of Spy II.

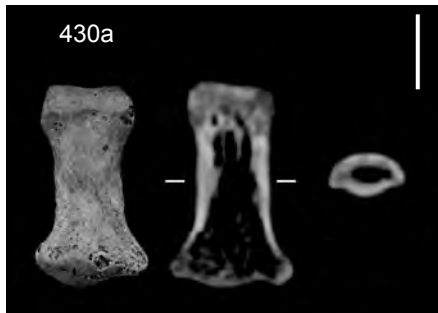

Figure 6. Spy 430a, a right middle third manual phalanx attributed to Spy II. X-ray: sagittal and transverse views derived from CT data showing the thin cortical bone of the diaphysis. Scale = 1 cm.

The dating of the manual phalanx (Spy 430a) at the CIO (33,940 \pm 220/-210 BP; GrA-32630; SF12) yielded a younger age falling outside the 2σ range of the dates for the Spy I and II teeth. The date obtained by the ORAU on another sample of the same bone using an ultrafiltration protocol (32,550 \pm 400 BP; OxA-17916; SF12) is ca. 1,500 years younger than the age obtained by the CIO. When calibrated, the 95.4 % probability distribution ranges from 39,600 to 38,000 cal BP for GrA-32630 and from 38,480 to 36,470 cal BP for OxA-17916 (UF²). Finally, the probability distribution of the oldest date from Spy 430a does not overlap with the range of other dates obtained for the two adult Neandertals (Spy 94a and 92b; see below).

The Spy VI Neandertal child

The recently published Spy VI Neandertal child was identified among the faunal remains

(Crevecoeur *et al.*, 2010, volume 2: chapter XX-2) and is represented by two mandibular fragments, along with 4 teeth recovered during the RBINS excavations of the slope deposits. A small mandibular fragment (Spy 646a) was sent to the CIO (Figure 7) as it preserved portions of the mandibular corpus also present on the symmetrical and morphologically similar Spy 194a fragment, therefore limiting the amount of lost information. The date obtained confirms it to indeed be Palaeolithic (32,970 \pm 200/-190 BP; GrA-32627; SF13). Although the C:N ratio could not be calculated due to the lack of preserved collagen, the other quality parameters ($\delta^{13}\text{C}$ and % C) are good. Nevertheless, the very young age may be tied to the sampled bone being very thin and therefore more susceptible to taphonomic processes than are the dentine and compact bone used for dating the two adults.

A second attempt was made to date the root of one of the teeth from Spy VI. In order to select the most appropriate sample, all the teeth were micro-CT scanned and the root dentine volumes were evaluated using Artcore 1.0 (www.nespos.org). The upper central incisor (Spy 589a; Figure 7) was selected given the insufficient volume of available dentine in the other teeth. The tooth was sent to the ORAU for sampling and dating using the ultrafiltration protocol. The sampling should have been limited to the root so that the crown would be available for further research, unfortunately it was broken during the sampling procedure. The crown dentine was then incorporated in the sample for collagen extraction. A preliminary age of 34,700 \pm 550 BP (OxA-17977) was recalculated to 33,950 \pm 550 BP (OxA-21610; Figure 8; SF14) taking into account the background limit for bone. In calibrated terms, the 95.4 % probability distribution ranges from 38,480 to 36,870 cal BP for GrA-32627 and from 40,490 to 37,300 cal BP for OxA-21610 (UF; Figure 9). There is almost no overlap between the probability distribution of the oldest date from Spy VI and the range of the oldest dates obtained for Spy I and Spy II.

Discussion of the age of the Neandertal remains

A majority of the youngest, directly dated Neandertal remains (< 38,000 BP) have recently been challenged by Pinhasi *et al.* (2011).

² UF = Ultrafiltrated samples.

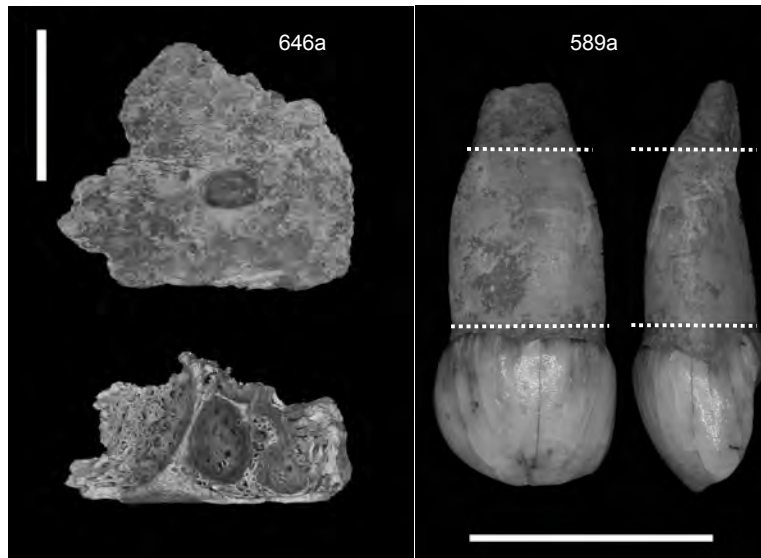

Figure 7. Neandertal remains attributed to Spy VI and directly dated by Crevecoeur *et al.* (2010).
 Left: Spy 646a, a right mandibular fragment in lateral and superior views; right:
 Spy 589a, a deciduous upper right central incisor in labial and mesial views.
 The dashed lines delimit the part of the root chosen for sampling (see text). Scales = 1 cm.

In many cases, their arguments appear plausible given differences of several millennia between the youngest and oldest dates of each site obtained on different remains from the same layer or several samples of the same bone dated by different laboratories (Figure 10). These authors challenge most of the dates obtained using the Longin extraction method (without ultrafiltration), deemed most likely responsible for the younger ages. If we consider only the oldest ultrafiltrated dates from each site, no date younger than ca. 38-40 ky BP can be considered valid (Pinhasi *et al.*, 2011: Fig. 3). Important inter-laboratory differences also suggest that some dating laboratories are not recommended for the accurate dating of very old samples (> 30,000 BP).

However, in our opinion these arguments are not applicable to all the Spy results; the three Neandertal individuals from Spy were dated by 11 direct radiocarbon dates providing ages ranging between 24,000 and 36,000 BP. Furthermore, the morphometric study of the remains supports the hypothesis that the youngest and oldest dates relate to the same individual (Spy II; Rougier *et al.*, volume 2: chapter XIX). The three oldest dates cluster around ca. 36,000 BP and there is no reason to suspect contamination as the different quality parameters of the collagen are all

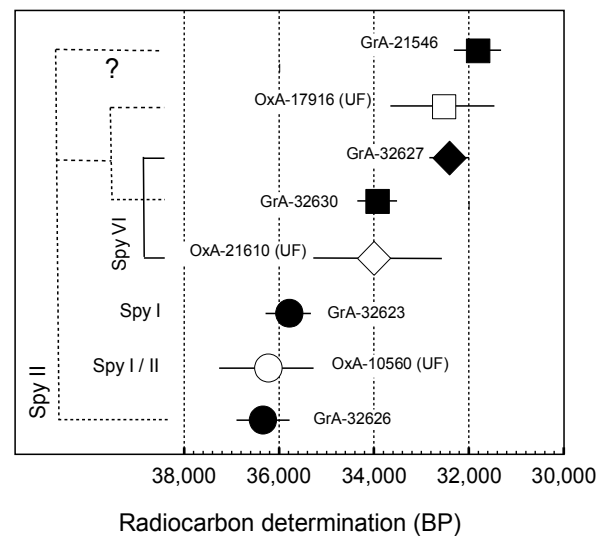

Figure 8. Uncalibrated dates for the Neandertal remains from Spy (direct ^{14}C dates and associated 2σ ranges); sample identifications are given in Tables 1 and 3. Black = AMS date without ultrafiltration; white = ultrafiltrated AMS date. Circles indicate dates for which contamination is not suspected; squares indicate dates for which contamination is suspected or if an older date was also obtained on the same sample (see text); diamonds indicate dates for which contamination is suspected, but the collagen parameters fall within the intervals of confidence (see text).

sound (yield > 1 %; C > 35 %; $-19.0 \text{‰} < \delta^{13}\text{C} > -22.0 \text{‰}$ and $2.9 < \text{C/N} > 3.6$; DeNiro, 1985). Taken as a whole, this suggests the radiocarbon ages for Spy I and Spy II to be reliable (Figure 8).

The dates produced from the Spy 572a scapula (Spy II?) are probably contaminated by consolidation with a glue or varnish possibly containing animal collagen. The taphonomic contamination of the very thin shaft fragment of the Spy 430a phalanx is also probable (Figure 8). The ultrafiltrated sample dated by the ORAU provided a younger age than the sample treated using the Longin procedure (CIO). While there is no overlap between the probability distribution of the Spy 430a dates and the oldest dates of Spy I/II around 36,000 BP, the C:N ratio for the ORAU sample (3.8) is well outside the accepted range, suggesting grounds for considering this age as problematic.

The two dates obtained for the Spy VI child are also younger than the oldest dates for Spy I and II, but fall within the range of the youngest dates obtained for the adults where the possibility of contamination by recent carbon is likely (see above). Only the first measurement from the ORAU falls within two standard deviations of the secure dates for the Spy adult Neandertals. Based on the results of the radiocarbon dating and related uncertainties, notably the complexity of the site's taphonomy, contemporaneity between Spy VI, Spy I and Spy II individuals remains possible, although we cannot exclude the possibility that Spy VI is actually younger than Spy I and Spy II.

The calibrated dates for the Spy Neandertals can be divided into two groups. The first comprises the three oldest dates situated at the rather steep part of the calibration curve and corresponds to a calibrated age between 42,000 and 41,000 cal BP. The second group is composed of the younger dates situated in a more complex part of the curve with several small plateaux (Figure 9). The resolution is lower in this part of the curve and different radiocarbon ages can provide similar calibrated age distributions.

These new dates from Spy (ca. 42-41 ky cal BP) are the youngest direct radiocarbon ages yet obtained on several Neandertal individuals from the same site (Spy I, Spy II, Spy VI) pro-

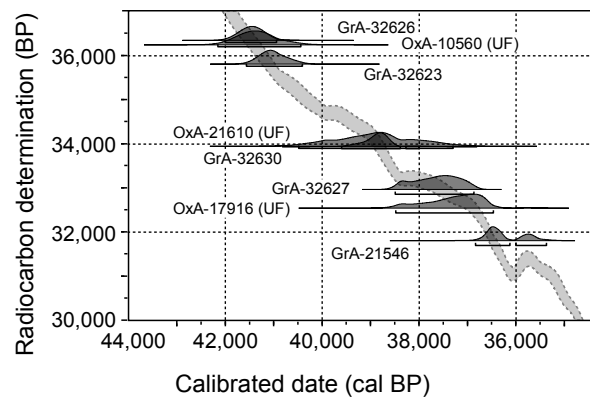

Figure 9. Distribution on the calibration curve of the calibrated dates (cal BP) obtained on the Neandertal specimens using OxCal 4.1 (Interface build: 54; Bronk Ramsey, 1994).

duced by different laboratories (CIO and ORAU) using both traditional and ultrafiltration pretreatment protocols. Even younger dates (ca. 36 ky cal BP) have been claimed for the final Neandertal populations of Southern Iberia; however, the recent re-dating of several specimens using ultrafiltration protocols has provided ages at least 10,000 ^{14}C years older than previously reported (Wood *et al.*, 2013a, 2013b). The Neandertals from Spy thus represent one of the latest Neandertal populations in Europe and clearly implicate them in the Middle to Upper Palaeolithic transition (Semal *et al.*, 2009; Figure 10).

Stratigraphic and archaeological context

Dating results

Imprecisions inherent in the original fieldwork documents and the mixing of the archaeological material precludes a precise evaluation of all the techno-complexes present at Spy. In much the same way, no reliable information is available concerning the exact archaeological context of the human fossils (Pirson *et al.*, this volume: chapter VI). With this in mind, faunal samples derived from the different levels defined by the discoverers in 1886 were dated such that a general radiocarbon chronology for the Spy stratigraphy could be established (Table 4). Samples selected by M. Germonpré were either labeled as belonging to a specific FBL or display anthropic traces such as ochre and/or cutmarks (Germonpré *et al.*, this volume: chapter XV).

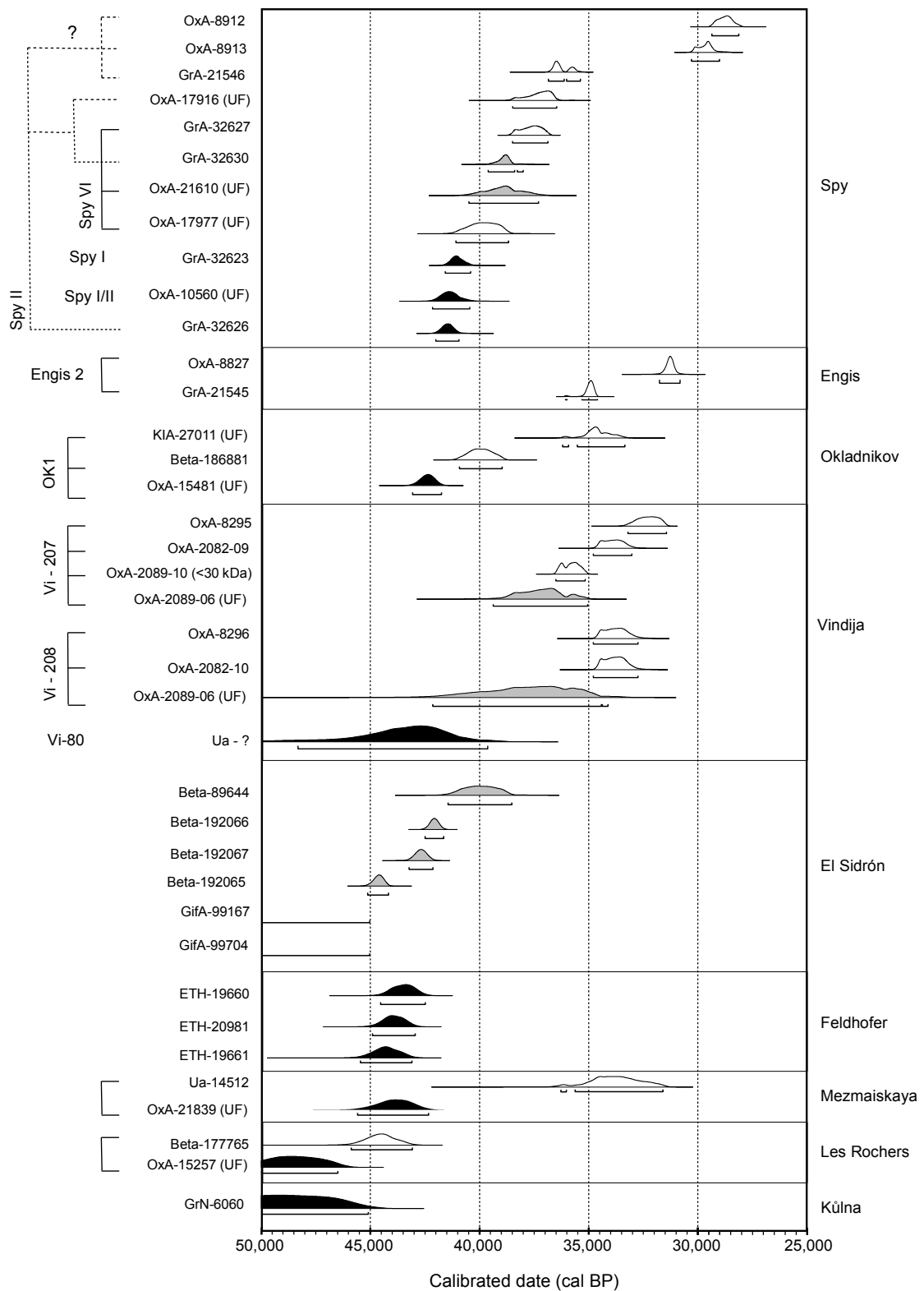

Figure 10. Distribution of calibrated dates (cal BP) obtained directly on Neandertal specimens. Data: Spy (Toussaint & Pirson, 2006; Semal *et al.*, 2009; present study); Engis (Toussaint & Pirson, 2006); Okladnikov (Krause *et al.*, 2007); Vindija (Serre *et al.*, 2004; Higham *et al.*, 2006); El Sidrón (Rosas *et al.*, 2006; De Torres *et al.*, 2010); Feldhofer (Schmitz *et al.*, 2002); Mezmaiskaya (Ovchinnikov *et al.*, 2000; Pinhasi *et al.*, 2011); Les Rochers-de-Villeneuve (Beauval *et al.*, 2005, 2006); Kůlna (Mook, 1988).

Lab number	¹⁴ C date (BP)	Age (BP) 95 % probability	Calibrated age (cal BP) 95 % probability	Specimen	FBL /Anthropic	Taxon / Description	Material
GrA-37936	25,670 +130/-120	25,930 – 25,430	30,850 – 30,240	Spy 13637 ULg	Upper FBL	<i>Coelodonta antiquitatis</i> Lower P3 or P4	dentine
GrA-37931	26,390 +140/-130	26,670 – 26,130	31,240 – 30,790	Spy 10640 ULg	Cutmarks Ochre	<i>Rangifer tarandus</i> Metacarpal frag.	bone
GrA-37934	29,040 +180/-160	29,400 – 28,720	34,490 – 33,160	Spy 13071 ULg	Middle FBL	<i>Rangifer tarandus</i> First phalanx	bone
GrA-44576	32,810 +250/-230	33,310 – 32,350	38,430 – 36,710	Spy IV2E 4207	<i>Moustérien en place</i>	<i>Equus caballus</i> Premolar / molar	dentine
GrA-44578	32,910 +250/-230	33,410 – 32,450	38,490 – 36,790	Spy 2F 13531	Ochre	<i>Coelodonta antiquitatis</i> Second molar	dentine
GrA-32612	34,410 +230/-210	34,870 – 33,990	40,210 – 38,740	Spy D4 19B 121 1480	Ochre	<i>Rangifer tarandus</i> Metatarsal frag.	bone
GrA-37932	34,580 +330/-290	35,240 – 34,000	40,550 – 38,780	Spy 14038 ULg	Lower FBL Red Layer Ochre	<i>Equus hydruntinus</i> Lower P2	dentine
GrA-32615	34,640 +240/-220	35,120 – 34,200	40,460 – 38,890	Spy D1 227 9D-E	Ochre	<i>Ursus arctos</i> Incisor	dentine
GrA-44546	36,920 +400/-350	37,720 – 36,220	42,440 – 41,220	Spy IV2A 13070	Middle FBL	<i>Rangifer tarandus</i> Metacarpal frag.	bone
GrA-37933	37,010 +440/-380	37,890 – 36,250	42,560 – 41,240	Spy 10261 ULg		<i>Mammuthus primigenius</i> Second molar	dentine
GrA-32616	42,330 +550/-450	43,430 – 41,430	46,540 – 44,750	Spy D3 19B 121 1474	<i>Déblais sup.</i>	<i>Mammuthus primigenius</i> Deciduous molar	dentine
GrA-44547	42,750 +850/-650	44,450 – 41,450	48,270 – 44,690	Spy IV2A 13534	Terrace Black layer	<i>Crocota crocuta</i> First molar	dentine
GrA-44548	42,950 +800/-650	44,550 – 41,650	48,360 – 44,890	Spy IV2A 13549	Terrace Black layer	<i>Mammuthus primigenius</i> Molar plate	dentine
GrA-32613	44,350 +650/-500	45,650 – 43,350	49,330 – 46,060	Spy D2 Pal Plateau 4	Cave's interior layer ZB	<i>Coelodonta antiquitatis</i> Deciduous molar	dentine

Table 4. New direct dates obtained on faunal samples from Spy. Calibration using OxCal 4.1 (Interface build: 54; Bronk Ramsey, 1994) and IntCal09 curve.

Several bone and ivory artefacts were also selected in order to date the human occupations, especially the “red layer” which contained mostly Aurignacian material (Table 5; Figure 11). With this in mind, samples were selected that could be attributed both to a chrono-cultural period and a definitive FBL. An unvarnished bone retoucher similar to examples from the De Puydt & Lohest excavations was also selected

from one of the RBINS collections (coll. Castin; Spy 8414). We also dated a flat, perforated ivory fragment in order to estimate the chronological position of the “red layer”. Despite the fact that this artefact comes from the 1952 excavations of the slope deposits, its ochre-stained surface and strong similarity with other “ear-like” pendants from the “red layer” make its original 1886 association with this layer quite certain (Otte, 1979;

Lab number	¹⁴ C date (BP)	Age (BP) 95 % probability	Calibrated age (cal BP) 95 % probability	Specimen	Taxon	Description	Material
GrA-33639	20,000 +100/-90	20,200 – 19,820	24,290 – 23,500	Spy SP4 - Spy 1952	<i>Mammuthus primigenius</i>	Fragment of a flat perforated “pendant”	ivory
GrA-32617	30,170 +160/-150	30,490 – 29,870	35,060 – 34,560	Spy SP1 - Spy 8414		Bone retoucher	bone
GrA-32619	32,830 +200/-190	33,230 – 32,450	38,380 – 36,750	Spy SP2 - Spy 1954		Flat, triangular spear point fragment	bone

Table 5. Radiocarbon dating results of archaeological samples from Spy. Calibration using OxCal 4.1 (Interface build: 54; Bronk Ramsey, 1994) and IntCal09 curve.

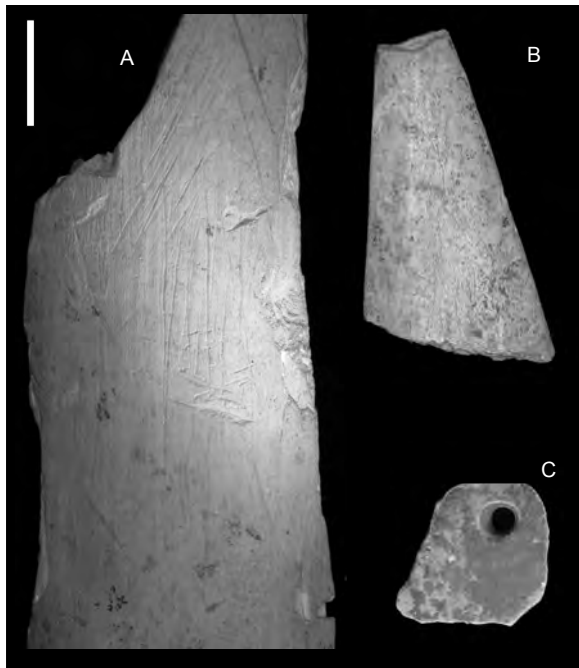

Figure 11. Archaeological samples from Spy dated in the present study. A: bone retoucher; B: flat triangular spear point fragment, likely a split-based antler point; C: flat perforated fragment of ivory. Scale = 1 cm.

Khlopachev, this volume: chapter XIV). Finally, a flat, triangular spear point fragment, likely a split-based antler point, was selected. While its archaeological context is uncertain as it was recovered from slope deposits excavated by F. Twisselmann in 1954, its morphology indicates a definitive cultural attribution to the Aurignacian (Flas *et al.*, this volume: chapter XII).

The stratigraphic context of the radiocarbon chronology

All of the samples selected from the three FBLs are within the accepted radiocarbon dating range (< 50,000 BP) and broadly agree with the stratigraphy described by the original excavators (Figure 12; De Puydt & Lohest, 1887). The oldest date was obtained on a *Coelodonta antiquitatis* sample (44,350 +650/-500 BP; GrA-32613) from the inner part of the cave (layer ZB according to Twisselmann's stratigraphy). Two other samples from the lower FBL (or "black layer") on the terrace were dated to ca. 43,000 BP (42,750 +850/-650 BP; GrA-44547 and 42,950 +800/-650 BP; GrA-44548). According to the minutes of a meeting following

the discovery of the Neandertal remains (see Semal *et al.*, this volume: chapter II), the two skeletons were found above this lower FBL and just below the "red layer". A *Mammuthus primigenius* milk molar discovered in the upper sediments (normally corresponding to the lower FBL following an inverse stratigraphy) was also dated to ca. 43,000 BP (42,330 +550/-450 BP; GrA-32616). Finally, a sample labeled "*Moustérien en place*" (*in situ* Mousterian) was dated to ca. 33,000 BP (32,810 +250/-230 BP; GrA-44576), however the quality parameters of the extracted collagen suggest this date may be problematic.

Six faunal samples can be directly (based on their labels) or indirectly (traces of ochre) associated with the second FBL ("red layer"). The oldest date is ca. 37,000 BP (37,010 +440/-380 BP; GrA-37933) and the youngest ca. 29,000 BP (29,040 +180/-160 BP; GrA-37934). This 8,000 year time span is probably an overestimation of the chronological range of the second FBL. Furthermore, considering the quality of the preserved collagen, some of the dates probably represent minimum ages. One date of ca. 25,600 BP (25,670 +130/-120 BP; GrA-37936) was obtained on a *Coelodonta antiquitatis* tooth labelled as coming from the upper (first) FBL, while a similar date (ca. 26,400 BP; GrA-37931) was obtained from a cut-marked and ochre stained *Rangifer tarandus* metacarpal; however, this diagenetically altered sample cannot be definitively assigned to the upper FBL.

The stratigraphic context of the Neandertal specimens

It is important to note that the chronological range of the dated samples from the second FBL is similar to that of the Neandertal remains from the lower FBL, including the contaminated samples (Figure 12). This chrono-stratigraphic discrepancy could be accounted for if the Spy Neandertals were in fact buried in graves, a hypothesis rejected by the discoverers, but now widely accepted (see Maureille *et al.*, volume 2: chapter XXI). Although the primary and/or intentional nature of the Neandertal burials at Spy is not unequivocal, the fact that the majority of the hand bones most likely belong to the same, more robust individual lends credence to De Puydt & Lohest's (1887) description of the ori-

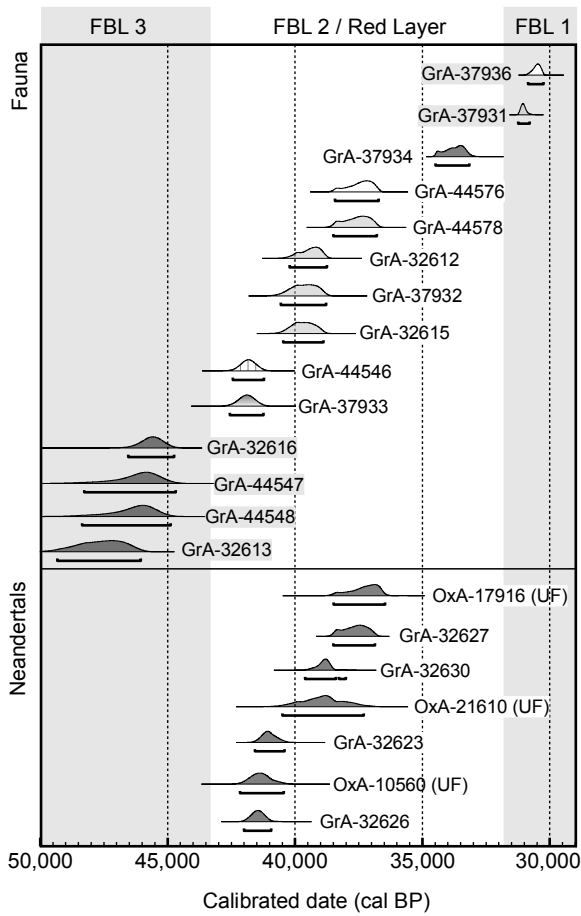

Figure 12. Distribution of the calibrated dates (cal BP) obtained directly on the Neandertal specimens and faunal remains. Data: Toussaint & Pirson (2006); Semal *et al.* (2009); present study.

ginal position of the now more complete skeleton (Rougier *et al.*, volume 2: chapter XIX). Moreover, the total absence of carnivore traces on the Neandertal remains supports the individuals having been immediately buried and protected from scavengers. The graves were probably cut into the lower FBL and it is therefore likely that they correspond chronologically to the second FBL occupation.

No information is available concerning exactly when the breccia corresponding to the “red layer” formed, though it may have followed the Neandertal occupation(s). Late Mousterian, LRJ and Aurignacian artefacts have all been identified from the second FBL. A date from a flat triangular spear point fragment provides a date of ca. 33,000 BP (32,830 +200/-190 BP;

GrA-32619) for the Aurignacian component. The LRJ and Late Mousterian techno-complexes cannot be directly dated as no specific osseous artefacts were recovered. An ochre stained *Ursus arctos* incisor with possible traces of a perforation has been dated to ca. 34,500 BP (34,640 +240/-220 BP; GrA-32615); however, it is impossible to determine if this possible pendant is associated with a Proto- or Early Aurignacian occupation given its comparable age with other sites (level VII of Arcy-sur-Cure [Higham *et al.*, 2010] or the lower levels of Abri Pataud [Higham *et al.*, 2011]) or those from the Châtelperronian levels of Arcy-sur-Cure (Hublin *et al.*, 1996; White, 2002; Zilhão, 2007; Higham *et al.*, 2010). Nevertheless, the association between LRJ artefacts and pendants is not supported by current data (Flas, 2008) and a Proto-Aurignacian or Early Aurignacian attribution is more compatible with our present understanding of the archaeological background. Unfortunately, the possibly perforated area was destroyed by the sampling procedure and is no longer available for use-wear analysis or other technological studies.

The Belgian context

Numerous Palaeolithic sites are known in Belgium including several Aurignacian and Mousterian sites as well as three caves containing “transitional” lithic artefacts. However, as elsewhere in Europe, most were excavated some time ago and lack any sound contextual information. Fieldwork conducted over the last decade in Belgium (see Pirson *et al.*, 2012 for a synthesis) has shown that no Mousterian assemblage younger than ca. 38-37,000 BP (Vrielynck, 1999; Toussaint & Pirson, 2006) exists, with the most recent occupations documented at Scladina (units 1A and T) and at Walou (layer CI-8) where a Neandertal tooth has recently been discovered (Draily *et al.*, 2011). Following a reassessment of the archaeological material from the Trou de l’Abîme and its reattribution to the Mousterian (Flas, 2008; Toussaint *et al.*, 2010), only two Belgian sites have yielded transitional industries: Spy and Goyet. While both contain LRJ assemblages, the majority of the excavations took place in the 19th century and no precise chronological or palaeoenvironmental data is available (Flas, 2008).

A very early age (around 40,000-38,000 BP) has been proposed for two Meuse River Basin Aurignacian assemblages: Trou Magrite (Otte & Straus, 1995) and Tiène des Maulins (Groenen, 2005), although in both cases the Aurignacian artefacts and associations between the dated samples and the archaeological assemblages are questionable (Flas, 2006, 2008). The earliest reliable ages available for the Belgian Aurignacian come from the open-air site of Maisières-Canal based on climatic and stratigraphic correlations (most likely ca. 32,000-33,000 BP; Haesaerts, 2004; Haesaerts & Dambon, 2004). The single date (32,830 +200/-190 BP; GrA-32619) from one of the probable split-based antler points found at Spy confirms Aurignacian populations to have been present in Belgium from at least around 32,000 BP. However, the quality parameters of the collagen sample suggest this date to represent a minimum age.

Finally, very few dates are available for the later phases of the Aurignacian in Belgium. The dates from the cave of Walou (ca. 30,000 BP; Dewez *et al.*, 1993; Pirson *et al.*, 2012) are worth mentioning; however, while dates more recent than 30,000 BP also exist, they appear unreliable (Flas, 2005). At present, no human remains are clearly associated with the Aurignacian in Belgium but see Rougier *et al.* (2013).

European context

The Jerzmanowice points from Spy demonstrate the same blade production technology; the majority of blades were produced on cores with two opposed striking platforms that, while comparable with other LRJ assemblages from Great Britain (Jacobi, 2007) and Poland (see Fig. 3 in Flas, this volume: chapter XI), differ from Aurignacian examples (Flas, 2008). LRJ assemblages similar to those from Spy and Goyet have been dated to between 38,000 BP and 30,000 BP, although the reliability of the most recent dates is debatable (Jacobi, 2007; Flas, 2008, 2011). At Ranis (Thuringia, Germany), the LRJ industry is intercalated between a Late Middle Palaeolithic layer and an Aurignacian one (Hülle, 1977). In the Nietoperzowa cave sequence (Jerzmanowice, Poland), the oldest LRJ assemblage (layer 6) has been dated

to ca. 38,000 BP (Chmielewski, 1961) with the most reliable ^{14}C dates for the LRJ in Great Britain being ca. 38-36,000 BP (Jacobi, 2007; Cooper *et al.*, 2012).

The new dates for the Spy Neandertals are thus closer to the chronological range of the LRJ (Flas, 2006; Jacobi, 2007) than they are to those for the Late Mousterian in Northern Europe, although it cannot be excluded that they are Mousterian. Unfortunately, uncertainties surrounding their discovery and context make the possibility that the Neandertal remains from Spy are associated with the LRJ assemblage impossible to verify. Despite the lack of human remains associated with this techno-complex, it has often been proposed that the LRJ was nonetheless made by the final Neandertals populations of Northern Europe given its cultural roots in the local Late Middle Palaeolithic (e.g. Otte, 1990).

In Northwest Europe, only the maxillary fragment from Kent's Cavern in South-west England could be of comparable age based on recent dates produced from unmodified faunal remains found around it (Higham *et al.*, 2011), however the integrity of the deposits has been judged highly dubious (Jacobi & Pettitt, 2000; Flas, 2008; White & Pettitt, 2012). Artefacts attributable to the LRJ were also discovered at Kent's Cavern, but they come from a different area of the cave (Jacobi, 2007). Although the maxilla has been attributed to AMH (Keith, 1927), its fragmentary state and the heavy wear of the teeth leave doubts open concerning this taxonomic attribution. Recently, Higham *et al.* (2011) proposed a very early age (ca. 42.5 ky cal BP) based on Bayesian modelling for the Kent's Cavern 4 maxillary bone, however the direct AMS date of the bone in question is actually much younger (OxA-1621; 30,900 \pm 900 BP) and is considered a minimum age due to probable contamination by modern carbon. A recent anatomical study reaffirmed an AMH attribution but with some Neandertal-like features (Higham *et al.*, 2011).

At Spy, the direct radiocarbon date obtained on the Aurignacian spear point fragment, likely a split-based antler point, is one of the earliest dates thus far published for the Aurignacian in Northwest Europe. Although pos-

sibly a minimum age, it is nevertheless coherent with what we know about the appearance of this techno-complex in the region (Flas, 2004, 2008).

CONCLUSION

The replacement of Neandertals by AMH across Eurasia is one of the most fiercely debated topics in palaeoanthropology (Gravina *et al.*, 2005; Orlando *et al.*, 2006; Trinkaus, 2007; Longo, 2012). Major cultural changes connected to the Middle to Upper Palaeolithic transition in Europe have been tied to a number of different techno-cultures: Late Mousterian, (Proto-)Aurignacian as well as several “transitional” techno-complexes including the Châtelperronian in France, the Uluzzian in Italy, the LRJ in Northwest Europe, the Bohunician and Szeletian in Central Europe, and the Streletskayan in Eastern Europe.

Several scenarios have been advanced to explain these biological and cultural “transitions” including those which posit a certain degree of continuity in both of these domains (e.g. Wolpoff *et al.*, 1994; Trinkaus, 2007). Others imply the complete replacement of the Neandertals by modern humans involving either processes of acculturation or independent technological innovations amongst the final Neandertals (e.g. Mellars, 2005 vs Zilhão, 2006; Hublin *et al.*, 2012).

In terms of the radiocarbon chronology for Northern Europe, dates of ca. 36,000 BP for the Spy Neandertals make them coeval with the LRJ, the only culture currently documented in the region during this time period and present in the middle FBL at Spy. The new radiocarbon dates discussed here also suggest that the Neandertal remains recovered from the lower FBL would have been buried by groups responsible for the formation of the second FBL containing the LRJ material. While a Neandertal-LRJ association remains plausible, it is difficult to demonstrate unequivocally as no direct relation was established during excavations combined with the fact that Late Mousterian material was also identified in the second FBL. Nevertheless, the authorship of the LRJ has most often been attributed to Neandertals and interpreted as representing a process of local evolution uncon-

nected to an acculturation process (Otte, 1990; Flas, 2006, 2011).

While acculturation scenarios have been proposed to explain the emergence of the Châtelperronian (e.g. Mellars, 1998, 1999), no archaeological evidence for analogous processes exists for the LRJ. This techno-complex has been identified across an area as large as the Northern European Plain where no contemporaneous Early Aurignacian occupations have yet been discovered (Flas, 2006, 2011). The oldest directly dated occurrence of early anatomically modern humans in Europe currently comes from Peștera cu Oase in Romania at ca. 35,000 BP (Trinkaus *et al.*, 2003) with examples of AMH remains from other European sites having been directly AMS dated to around 32,000 BP (Wild *et al.*, 2005; Soficaru *et al.*, 2006, 2007; Henry-Gambier & Sacchi, 2008; Prat *et al.*, 2011). No clear chronological overlap between Neandertals and modern human populations in Europe is therefore perceptible based solely on the direct AMS dating of human fossils. If the maxilla from Kent's Cavern is indeed AMH and as old as Higham *et al.* (2011) propose, the arrival of AMH populations in this part of Europe could be much earlier than previously thought and an overlap between the two populations would appear plausible. Moreover, the recent taxonomic attribution of isolated teeth from the Grotta del Cavallo (Apulia, Southern Italy) to AMH associates the Uluzzian “transitional industry” with AMH, rather than with the Neandertals as previously thought (Riel-Salvatore, 2009). The Bayesian modelling of dates produced from shells at this site once again indicate a very early age of 43-44 ky cal BP (Benazzi *et al.*, 2011), however the contemporaneity of these objects and the human remains cannot be unequivocally demonstrated. Finally, while the age of the early Upper Palaeolithic settlements at Willendorf (Nigst, 2010) could also support an early presence of AMH groups in Central Europe, the lack of synchronous Neandertal sites in the vicinity of Willendorf precludes identifying contemporary occupations by the two groups.

Taken as a whole, the above discussion suggests a complex mosaic of biological and cultural changes to have occurred during the Middle-to-Upper Palaeolithic transition that perhaps assumed various guises in different

European regions. However, the precise chronology and palaeoenvironmental context of the human fossils and industries of this period are not yet accurately known and the impact of climate on cultural and biological change still remains poorly documented. This situation is primarily due to insufficient contextual information meaning that the chronological framework rests almost entirely on radiocarbon dates. Different hypotheses held to account for changes associated with the Middle to Upper Palaeolithic transition appear limited by imprecisions inherent in the data collected during early excavations and the resolution provided by radiocarbon dating (Pettitt & Pike, 2001; Higham, 2011). The recent use of Bayesian modelling presents a very interesting exploratory tool, however if this new category of “probabilistic dates” is used uncritically or based on uncertain field data new problems may be introduced. The direct dating of collagen-specific amino acids such as hydroxyproline could also represent a major methodological improvement allowing radiocarbon ages to be obtained from old contaminated samples from which traditional and ultrafiltration extraction protocols failed to produce accurate ages (Marom *et al.*, 2012).

New multidisciplinary excavations are absolutely necessary to better understand various replacement scenario(s) proposed for different parts of Europe. The richness of Palaeolithic sites in the Belgian Meuse Valley, the excellent collagen preservation of organic artefacts suitable for both radiocarbon dating and isotopic analyses combined with thick archaeological deposits that can be correlated with palaeoclimatic sequences established for Central European loess deposits makes the region of key interest for addressing these issues (Haesaerts *et al.*, 2003; Pirson *et al.*, 2006, 2012).

ACKNOWLEDGEMENTS

The Spy dating program was funded by the FRS-FNRS through a grant to AH. The dates produced by the ORAU were funded by the NERC.

BIBLIOGRAPHY

- AERTS-BIJMA A. T., VAN DER PLICHT J. & MEIJER H. A. J., 2001. Automatic AMS sample combustion and CO₂ collection. *Radiocarbon*, **43**: 293-298.
- BEAUVAL C., LACRAMPE-CUYAUBÈRE F., MAUREILLE B. & TRINKAUS E., 2006. Direct radiocarbon dating and stable isotopes of the neandertal femur from Les Rochers-de-Villeneuve (Lussac-les-Châteaux, Vienne). *Bulletins et mémoires de la Société d'Anthropologie de Paris*, **18** (1-2): 35-42.
- BEAUVAL C., MAUREILLE B., LACRAMPE-CUYAUBÈRE F., SERRE D., PERESSINOTTO D., BORDES J.-G., COCHARD D., COUCHOUD I., DUBRASQUET D., LAROULANDIE V., LENOBLE A., MALLYE J.-B., PASTY S., PRIMAULT J., ROHLAND N., PÄÄBO S. & TRINKAUS E., 2005. A late Neandertal femur from Les Rochers-de-Villeneuve, France. *Proceedings of the National Academy of Sciences USA*, **102** (20): 7085-7090.
- BENAZZI S., DOUKA K., FORNAI C., BAUER C. C., KULLMER O., SVOBODA J., PAP I., MALLEGNI F., BAYLE P., COQUERELLE M., CONDEMI S., RONCHITELLI A., HARVATI K. & WEBER G. W., 2011. Early dispersal of modern humans in Europe and implications for Neanderthal behaviour. *Nature*, **479**: 525-528.
- BOCHERENS H., BILLIOU D., MARIOTTI A., TOUSSAINT M., PATOU-MATHIS M., BONJEAN D. & OTTE M., 2001. New isotopic evidence for dietary habits of Neandertals from Belgium. *Journal of Human Evolution*, **40**: 497-505.
- BORDES F., 1959. Le contexte archéologique des Hommes du Moustier et de Spy. *L'Anthropologie*, **63**: 154-157.
- BREUIL H., 1912. Remarques sur les divers niveaux archéologiques du gisement de Spy (Belgique). *Revue Anthropologique*, **22**: 126-129.
- BRONK RAMSEY C., 1994. Analysis of Chronological Information and Radiocarbon Calibration: The Program OxCal. *Archaeological Computing Newsletter*, **41**: 11-16.
- BRONK RAMSEY C., STAFF R. A., BRYANT C. L., BROCK F., KITAGAWA H., VAN DER PLICHT J., SCHLOLAUT G., MARSHALL M. H., BRAUER A., LAMB H. F., PAYNE R. L., TARASOV P. E., HARAGUCHI T., GOTANDA K., YONENOBU H., YOKOYAMA Y., TADA R. & NAKAGAWA T.,

2012. A complete terrestrial radiocarbon record for 11.2 to 52.8 kyr B.P. *Science*, **338**: 370-374.
- BUCHA V., 1970. Influence of the earth's magnetic field on radiocarbon dating. In: I. U. OLSSON (ed.), *Radiocarbon variation and absolute chronology*. Nobel Symposium, 12th. John Wiley & Sons: 501-511.
- CAMPBELL J. B., 1980. Le problème des subdivisions du Paléolithique supérieur britannique dans son cadre européen. *Bulletin de la Société royale belge d'Anthropologie et de Préhistoire*, **91**: 39-77.
- CHMIELEWSKI W., 1961. *La civilisation de Jerzmanowice*. Wrocław-Warszawa-Kraków, Instytut Historii Kultury Materialnej Polskiej Akademii Nauk.
- COOPER L. P., THOMAS J. S., BEAMISH M. G., GOULDWELL A., COLLCUTT S. N., WILLIAMS J., JACOBI R. M., CURRANT A. & HIGHAM T. F. G., 2012. An Early Upper Palaeolithic open-air station and mid-Devensian hyaena den at Grange Farm, Glaston, Rutland, UK. *Proceedings of the Prehistoric Society*, **78**: 73-93.
- CREVECOEUR I., BAYLE P., ROUGIER H., MAUREILLE B., HIGHAM T., VAN DER PLICHT J., DE CLERCK N. & SEMAL P., 2010. The Spy VI child: A newly discovered Neandertal infant. *Journal of Human Evolution*, **59**: 641-656.
- DAUCHOT-DEHON M. & HEYLEN J., 1979. Institut Royal du Patrimoine Artistique Radiocarbon Dates VI. *Radiocarbon*, **21**: 180-185.
- DAURA J., SANZ M., PIKE A. W., SUBIRÀ M. E., FORNÓS J. J., FULLOLA J. M., JULIÀ R. & ZILHÃO J., 2010. Stratigraphic context and direct dating of the Neandertal mandible from Cova del Gegant (Sitges, Barcelona). *Journal of Human Evolution*, **59**: 109-122.
- DENIRO M. J., 1985. Postmortem preservation and alteration of in vivo bone collagen isotope ratios in relation to paleodietary reconstruction. *Nature*, **317** (6040): 806-809.
- DE PUYDT M. & LOHEST M., 1887. L'homme contemporain du Mammouth à Spy (Namur). In: *Compte-rendu du Congrès de Namur, 1886*. Annales de la Fédération Archéologique et Historique de Belgique: 207-240.
- DE TORRES T., ORTIZ J. E., GRÜN R., EGGINS S., VALLADAS H., MERCIER N., TISNÉRAT-LABORDE N., JULIÀ R., SOLER V., MARTÍNEZ E., SÁNCHEZ-MORAL S., CAÑAVÉRAS J. C., LARIO J., BADAL E., LALUEZA-FOX C., ROSAS A., SANTAMARÍA D., DE LA RASILLA M. & FORTEA J., 2010. Dating of the hominid (*Homo neanderthalensis*) remains accumulation from El Sidrón cave (Piloña, Asturias, north Spain): an example of a multi-methodological approach to the dating of Upper Pleistocene sites. *Archaeometry*, **52**: 680-705.
- DE VRIES H., 1958. Variation in concentration of radiocarbon with time and location on earth. *KNAW Proceedings*, **B61**: 1-9.
- DEWEZ M., COLLCUTT S. N., CORDY J.-M., GILOT E., GROESSENS-VAN DYCK M.-C., HEIM J., KOZŁOWSKI S., SACHSE-KOZŁOWSKA E., LACROIX D. & SIMONET P., 1993. *Recherches à la grotte Walou à Trooz (province de Liège, Belgique), premier rapport de fouille*. Liège, Société wallonne de paléontologie, Mémoire 7.
- DRAILY C., TOUSSAINT M. & PIRSON S. (dir.), 2011. *La grotte Walou à Trooz (Belgique). Fouilles de 1996 à 2004. Volume 2. Les sciences de la vie et les datations*. Namur, Service public de Wallonie, Monographie (Études et documents, Archéologie, **21**): 241 p.
- FERRIER C., 2002. Les dépôts d'entrée de grotte. In: J.-C. MISKOVSKY (ed.), *Géologie de la Préhistoire*. Paris, Association pour l'étude de l'environnement géologique de la préhistoire: 189-205.
- FLAS D., 2004. L'atelier de débitage de Maisières dans le contexte de l'Aurignacien du Nord-Ouest de l'Europe. In: R. MILLER, P. HAESAERTS & M. OTTE (dir.), *L'atelier de taille aurignacien de Maisières-Canal (Belgique)*. Liège, Études et Recherches Archéologiques de l'Université de Liège, **110**: 113-120.
- FLAS D., 2005. Nouvelles datations de deux ensembles aurignaciens du bassin mosan. *Anthropologica et Praehistorica*, **116**: 233-236.
- FLAS D., 2006. *La transition du Paléolithique moyen au supérieur dans la plaine septentrionale de l'Europe. Les problématiques du Lincombien-Ranisien-Jerzmanowicien*. Thèse de doctorat inédite, Université de Liège, 2 vol.: 370 p., 315 pl.
- FLAS D., 2008. *La transition du Paléolithique moyen au supérieur dans la plaine septentrionale de l'Europe*. *Anthropologica et Praehistorica*, **119**: 254 p.

- FLAS D., 2011. The Middle to Upper Paleolithic transition in Northern Europe: the Lincombian-Ranisian-Jerzmanowician and the issue of acculturation of the last Neanderthals. *World Archaeology*, **43** (4): 605-627.
- FRAIPONT J. & LOHEST M., 1886. La race humaine de Néanderthal ou de Canstadt, en Belgique. Recherches ethnographiques sur des ossements humains découverts dans les dépôts quaternaires d'une grotte à Spy et détermination de leur âge géologique. Note préliminaire. *Bulletins de l'Académie royale de Belgique*, 3ème Série, **12** (12): 741-784.
- GOLDBERG P. & SHERWOOD S. C., 2006. Deciphering Human Prehistory Through the Geoarchaeological Study of Cave Sediments. *Evolutionary Anthropology*, **15**: 20-36.
- GRAVINA B., MELLARS P. & BRONK RAMSEY C., 2005. Radiocarbon dating of interstratified Neanderthal and early modern human occupations at the Chatelperronian type-site. *Nature*, **483**: 51-56.
- GROENEN M., 2005. Interprétation des datations absolues aurignaciennes et moustériennes pour la grotte-abri du *Tiène des Maulins*. *Notae Praehistoricae*, **25**: 71-79.
- GRÖNING F., KEGLER J. F. & WENIGER G.-C., 2007. Die digitale Welt der Neandertaler – NESPOS, ein Online-Archiv für die Neandertalerforschung. *Archäologisches Korrespondenzblatt*, **37**: 321-333.
- HAESAERTS P., 2004. Maisières-Canal (2000-2002): cadre stratigraphique. In: R. MILLER, P. HAESAERTS & M. OTTE (dir.), *L'atelier de taille aurignacien de Maisières-Canal (Belgique)*. Liège, Études et Recherches Archéologiques de l'Université de Liège, **110**: 13-26.
- HAESAERTS P., BORZIAK I., CHIRICA V., DAMBLON F., KOULAKOVSKA L. & VAN DER PLICHT J., 2003. The East-Carpathian loess record: a reference for the Middle and Late Pleniglacial stratigraphy in Central Europe. *Quaternaire*, **14**: 163-188.
- HAESAERTS P. & DAMBLON F., 2004. Maisières-Canal: Les dates radiocarbones. In: R. MILLER, P. HAESAERTS & M. OTTE (dir.), *L'atelier de taille aurignacien de Maisières-Canal (Belgique)*. Liège, Études et Recherches Archéologiques de l'Université de Liège, **110**: 27-28.
- HENRY-GAMBIER D. & SACCHI D., 2008. La Crozade V-VI (Aude, France): Un des plus anciens hommes d'anatomie moderne d'Europe occidentale. *Bulletins et Mémoires de la Société d'Anthropologie de Paris*, **20**: 79-104.
- HIGHAM T., 2011. European Middle and Upper Palaeolithic radiocarbon dates are often older than they look: problems with previous dates and some remedies. *Antiquity*, **85**: 235-249.
- HIGHAM T., BRONK RAMSEY C., KARAVANIĆ I., SMITH F. H. & TRINKAUS E., 2006. Revised direct radiocarbon dating of the Vindija G₁ Upper Paleolithic Neandertals. *Proceedings of the National Academy of Sciences USA*, **103**: 553-557.
- HIGHAM T., COMPTON T., STRINGER C., JACOBI R., SHAPIRO B., TRINKAUS E., CHANDLER B., GRÖNING F., COLLINS C., HILLSON S., O'HIGGINS P., FITZGERALD C. & FAGAN M., 2011. The earliest evidence for anatomically modern humans in northwestern Europe. *Nature*, **479**: 521-524.
- HIGHAM T., JACOBI R., JULIEN M., DAVID F., BASELL L., WOOD R., DAVIES W. & BRONK RAMSEY C., 2010. Chronology of the Grotte du Renne (France) and implications for the context of ornaments and human remains within the Châtelperronian. *Proceedings of the National Academy of Sciences USA*, **107**: 20234-20239.
- HUBLIN J.-J., SPOOR F., BRAUN M., ZONNEVELD F. & CONDEMI S., 1996. A late Neanderthal associated with Upper Palaeolithic artefacts. *Nature*, **381**: 224-226.
- HUBLIN J.-J., TALAMO S., JULIEN M., DAVID F., CONNET N., BODU P., VANDERMEERSCH B. & RICHARDS M. P., 2012. Radiocarbon dates from the Grotte du Renne and Saint-Césaire support a Neanderthal origin for the Châtelperronian. *Proceedings of the National Academy of Sciences USA*, **109**: 18743-18748.
- HÜLLE W., 1977. *Die Ilsenhöhle unter Burg Ranis-Thüringen*. Stuttgart, Gustav Fischer Verlag.
- JACOBI R., 2007. A collection of Early Upper Palaeolithic artefacts from Beedings, near Pulborough, West Sussex and the context of similar finds from British Isles. *Proceedings of the Prehistoric Society*, **73**: 229-325.
- JACOBI R. & PETTITT P. B., 2000. An Aurignacian point from Uphill Quarry, Somerset, and the colon-

- isation of Britain by *Homo sapiens sapiens*. *Antiquity*, **74**: 513-518.
- KEITH A., 1927. Report on a fragment of a human jaw found at a depth of (10 1/2 ft) 3.2 m in the cave earth of the vestibule of Kent's Cavern. *Transactions of the Proceedings of the Torquay Natural History Society*, **5**: 1-2.
- KRAUSE J., ORLANDO L., SERRE D., VIOLA B., PRÜFER K., RICHARDS M. P., HUBLIN J.-J., HÄNNI C., DEREVIANKO A. P. & PÄÄBO S., 2007. Neanderthals in central Asia and Siberia. *Nature*, **449**: 902-904.
- LANTING J. N. & VAN DER PLICHT J., 1998. Reservoir effects and apparent ¹⁴C ages. *Journal of Irish Archaeology*, **9**: 151-165.
- LONGIN R., 1970. *Extraction du collagène des os fossiles pour leur datation par la méthode du carbone 14*. Thèse de doctorat, Université de Lyon.
- LONGO L. (ed.), 2012. Middle to Upper Paleolithic biological and cultural shift in Eurasia. *Quaternary International*, **259**: 1-112.
- MAROM A., McCULLAGH J. S., HIGHAM T. F., SINITSYN A. A. & HEDGES R. E., 2012. Single amino acid radiocarbon dating of Upper Paleolithic modern humans. *Proceedings of the National Academy of Sciences USA*, **109** (18): 6878-6881.
- MELLARS P., 1998. The Fate of the Neanderthals. *Nature*, **395**: 539-540.
- MELLARS P., 1999. Châtelperronian chronology and the case for Neandertal/Modern human "acculturation" in Western Europe. In: C. B. STRINGER, R. N. E. BARTON & J. C. FINLAYSON (ed.), *Neanderthals on the Edge*. Oxford, Oxbow Books: 33-39.
- MELLARS P., 2005. The Impossible Coincidence. A Single-Species Model for the Origins of Modern Human Behavior in Europe. *Evolutionary Anthropology*, **14**: 12-27.
- MOOK W. G., 1988. Radiocarbon-Daten aus der Kůlna-Höhle. In: K. VALOCH (ed.), *Die Erforschung der Kůlna-Höhle 1961-1976*, 24 (N.S. 16). Brno, Morawske muzeum, Anthropos Institut: 285-286.
- MOOK W. G. & STREURMAN H. J., 1983. Physical and chemical aspects of radiocarbon dating. *PACT Publications*, **8**: 31-55.
- NIGST P. R., 2010. The Aurignacian in Eastern Austria: Preliminary Results of an Analysis of the Lithic Technology of Willendorf II, layer 3, and its Implications for the Transition from Middle to Upper Palaeolithic in Central Europe. In: Chr. NEUGEBAUER-MARESCH & L. R. OWEN (ed.), *New Aspects of the Central and Eastern European Upper Palaeolithic - methods, chronology, technology and subsistence*. Mitteilungen der prähistorischen Kommission, **72**: 81-99.
- OLSSON I. U., 2009. ¹⁴C dating history: early days, questions, and problems met. *Radiocarbon*, **51**: 1-43.
- ORLANDO L., DARLU P., TOUSSAINT M., BONJEAN D., OTTE M. & HÄNNI C., 2006. Revisiting Neandertal diversity with a 100,000 year old mtDNA sequence. *Current Biology*, **16**: 400-402.
- OTTE M., 1979. *Le Paléolithique supérieur ancien en Belgique*. Monographies d'archéologie nationale, **5**. Bruxelles, Musées royaux d'Art et d'Histoire: 684 p.
- OTTE M., 1990. Les industries aux pointes foliacées du Nord-Ouest européen. *Études et Recherches Archéologiques de l'Université de Liège*, **42**: 247-269.
- OTTE M. & STRAUS L. G. (ed.), 1995. *Le Trou Magrite: fouilles 1991-1992. Résurrection d'un Site Classique en Wallonie*. Liège, Études et Recherches Archéologiques de l'Université de Liège, **69**.
- OVCHINNIKOV I. V., GÖTHERSTRÖM A., ROMANOVAK G. P., KHARITONOV V. M., LIDÉN K. & GOODWIN W., 2000. Molecular analysis of Neandertal DNA from the northern Caucasus. *Nature*, **404**: 490-493.
- PETTITT P. B. & PIKE A. W. G., 2001. Blind in a cloud of data: problems with the chronology of Neandertal extinction and anatomically modern human expansion. *Antiquity*, **75**: 415-420.
- PINHASI R., HIGHAM T. F. G., GOLOVANOVA L. V. & DORONICHEV V. B., 2011. Revised age of late Neandertal occupation and the end of the Middle Paleolithic in the northern Caucasus. *Proceedings of the National Academy of Sciences USA*, **108**: 8611-8616.
- PIRSON S., 2007. *Contribution à l'étude des dépôts d'entrée de grotte en Belgique au Pléistocène supérieur. Stratigraphie, sédimentogenèse et paléoenvironnement*. Thèse de doctorat inédite, Université de Liège.

- PIRSON S., FLAS D., ABRAMS G., BONJEAN D., COURT-PICON M., DI MODICA K., DRAILY C., DAMBLON F., HAESAERTS P., MILLER R., ROUGIER H., TOUSSAINT M. & SEMAL P., 2012. Chronostratigraphic context of the Middle to Upper Palaeolithic transition. Recent data from Belgium. *Quaternary International*, **259**: 78-94.
- PIRSON S., HAESAERTS P., COURT-PICON M., DAMBLON F., TOUSSAINT M., DEBENHAM N. & DRAILY C., 2006. Belgian cave entrance and rock-shelter sequences as palaeoenvironmental data recorders: the example of Walou Cave. *Geologica Belgica*, **9** (3-4): 275-286.
- PRAT S., PÉAN S. C., CRÉPIN L., DRUCKER D. G., PUAUD S. J., VALLADAS H., LÁZNIČKOVÁ-GALETOVÁ M., VAN DER PLICHT J. & YANEVICH A., 2011. The Oldest Anatomically Modern Humans from Far Southeast Europe: Direct Dating, Culture and Behavior. *PLoS ONE*, **6** (6): e20834.
- REIMER P. J., 2012. Refining the radiocarbon timescale. *Science*, **338**: 337-338.
- REIMER P. J., BAILLIE M. G. L., BARD E., BAYLISS A., BECK J. W., BLACKWELL P. G., BRONK RAMSEY C., BUCK C. E., BURR G. S., EDWARDS R. L., FRIEDRICH M., GROOTES P. M., GUILDERSON T. P., HAJDAS I., HEATON T. J., HOGG A. G., HUGHEN K. A., KAISER K. F., KROMER B., McCORMAC F. G., MANNING S. W., REIMER R. W., RICHARDS D. A., SOUTHON J. R., TALAMO S., TURNEY C. S. M., VAN DER PLICHT J. & WEYHENMEYER C. E., 2009. IntCal09 and Marine09 radiocarbon age calibration curves, 0-50,000 years cal BP. *Radiocarbon*, **51**: 1111-1150.
- REIMER P. J., BARD E., BAYLISS A., BECK J. W., BLACKWELL P. G., BRONK RAMSEY C., BUCK C. E., CHENG H., EDWARDS R. L., FRIEDRICH M., GROOTES P. M., GUILDERSON T. P., HAFLIDASON H., HAJDAS I., HATTÉ C., HEATON T. J., HOFFMANN D. L., HOGG A. G., HUGHEN K. A., KAISER K. F., KROMER B., MANNING S. W., NIU M., REIMER R. W., RICHARDS D. A., SCOTT E. M., SOUTHON J. R., STAFF R. A., TURNEY C. S. M. & VAN DER PLICHT J., 2013. IntCal13 and Marine13 Radiocarbon Age Calibration Curves 0-50,000 Years cal BP. *Radiocarbon*, **55** (4): 1869-1887.
- RIEL-SALVATORE J., 2009. What Is a 'Transitional' Industry? The Uluzzian of Southern Italy as a Case Study. In: M. CAMPS & P. CHAUHAN (ed.), *Sourcebook of Paleolithic Transitions. Methods, Theories, and Interpretations*. New York, Springer: 377-396.
- ROSAS A., MARTÍNEZ-MAZA C., BASTIR M., GARCÍA-TABERNEO A., LALUEZA-FOX C., HUGUET R., ORTIZ J. E., JULIÀ R., SOLER V., DE TORRES T., MARTÍNEZ E., CAÑAVÉRAS J. C., SÁNCHEZ-MORAL S., CUEZVA S., LARIO J., SANTAMARÍA D., DE LA RASILLA M. & FORTEA J., 2006. Paleobiology and comparative morphology of a late Neandertal sample from El Sidrón, Asturias, Spain. *Proceedings of the National Academy of Sciences USA*, **103**: 19266-19271.
- ROUGIER H., CREVECOEUR I., BEAUVAL C., FLAS D., BOCHERENS H., WISSING C., GERMONPRÉ M., SEMAL P. & VAN DER PLICHT J., 2013. The first Upper Paleolithic human remains from Belgium: Aurignacian, Gravettian and Magdalenian fossils at the "Troisième caverne" of Goyet. *PaleoAnthropology*, **2013**: A 33.
- SCHMITZ R. W., SERRE D., BONANI G., FEINE S., HILLGRUBER F., KRAINITZKI H., PÄÄBO S. & SMITH F. H., 2002. The Neandertal type site revisited: interdisciplinary investigations of skeletal remains from the Neander Valley, Germany. *Proceedings of the National Academy of Sciences USA*, **99**: 13342-13347.
- SEMAL P., CORNELISSEN E. & CAUWE N., 2004. MARS: Multimedia Archaeological Research System. *Notae Praehistoricae*, **24**: 203-208.
- SEMAL P., ROUGIER H., CREVECOEUR I., JUNGELS C., FLAS D., HAUZEUR A., MAUREILLE B., GERMONPRÉ M., BOCHERENS H., PIRSON S., CAMMAERT L., DE CLERCK N., HAMBUCKEN A., HIGHAM T., TOUSSAINT M. & VAN DER PLICHT J., 2009. New Data on the Late Neandertals: Direct Dating of the Belgian Spy Fossils. *American Journal of Physical Anthropology*, **138**: 421-428.
- SEMAL P., TOUSSAINT M., MAUREILLE B., ROUGIER H., CREVECOEUR I., BALZEAU A., BOUCHNEB L., LOURYAN ST., DE CLERCK N. & RAUSIN L., 2005. Numérisation des restes humains néandertaliens belges. Préservation patrimoniale et exploitation scientifique. *Notae Praehistoricae*, **25**: 25-38.
- SEMAL P., TWIESSELMANN FR., HAUZEUR A. & DEWEZ M., 1996. Étude d'une face humaine découverte dans les niveaux « gravettiens » des dépôts de pente de la grotte de Spy. Fouilles de Fr.

- Twisselmann (1950-54). *Notae Praehistoricae*, **16**: 171-181.
- SERRE D., LANGANEY A., CHECH M., TESCHLER-NICOLA M., PAUNOVIĆ M., MENNECIER P., HOFREITER M., POSSNERT G. & PÄÄBO S., 2004. No evidence of Neanderthal mtDNA contribution to early modern humans. *PLoS Biology*, **2**: 0313-0317.
- SKINNER A. R., BLACKWELL B. A. B., MARTINA S., ORTEGA A., BLICKSTEIN J. I. B., GOLOVANOVA L. V. & DORONICHEV V. B., 2005. ESR dating at Mezmaiskaya Cave, Russia. *Applied Radiation and Isotopes*, **62**: 219-224.
- SMITH F. H., TRINKAUS E., PETTITT P. B., KARAVANIĆ I. & PAUNOVIĆ M., 1999. Direct radiocarbon dates for Vindija G₁ and Velika Pećina Late Pleistocene hominid remains. *Proceedings of the National Academy of Sciences USA*, **96**: 12281-12286.
- SOFICARU A., DOBOȘ A. & TRINKAUS E., 2006. Early modern humans from the Peștera Muierii, Baia de Fier, Romania. *Proceedings of the National Academy of Sciences USA*, **103**: 17196-17201.
- SOFICARU A., PETREA C., DOBOȘ A. & TRINKAUS E., 2007. The human cranium from Peștera Cioclovina Uscată, Romania. *Current Anthropology*, **48**: 611-619.
- STUIVER M., 1965. Carbon-14 content of 18th- and 19th-century wood: variations correlated with sunspot activity. *Science*, **149**: 533-535.
- STUIVER M. & POLACH H. A., 1977. Radiocarbon 1977, Discussion. Reporting of 14C data. *Radiocarbon*, **19**: 355-363.
- TEXIER J.-P., KERVAZO B., LENOBLE A. & NESPOULET R., 2004. *Sédimentogenèse des sites préhistoriques du Périgord*. Fieldtrip guidebook of the AGSO-ASF (23-24/04/2004). Paris, Association des sédimentologues français.
- TOUSSAINT M., 2007. Les sépultures néolithiques du bassin mosan wallon et leurs relations avec les bassins de la Seine et du Rhin. *Archaeologia Mosellana*, **7**: 507-549.
- TOUSSAINT M., OLEJNICZAK A. J., EL ZAATARI S., CATTELAİN P., FLAS D., LETOURNEUX C. & PIRSON S., 2010. The Neanderthal lower right deciduous second molar from the “Trou de l'Abîme” at Couvin, Belgium. *Journal of Human Evolution*, **58**: 56-67.
- TOUSSAINT M. & PIRSON S., 2006. Neanderthal Studies in Belgium: 2000-2005. *Periodicum Biologorum*, **108**: 373-387.
- TRINKAUS E., 2006. Modern Human versus Neanderthal Evolutionary Distinctiveness. *Current Anthropology*, **47**: 597-620.
- TRINKAUS E., 2007. European early modern humans and the fate of the Neanderthals. *Proceedings of the National Academy of Sciences USA*, **104**: 7367-7372.
- TRINKAUS E., MOLDOVAN O., MILOTA Ș., BÎLGAR A., SARCINA L., ATHREYA S., BAILEY S. E., RODRIGO R., GHERASE M., HIGHAM T., BRONK RAMSEY C. & VAN DER PLICHT J., 2003. An early modern human from the Peștera cu Oase, Romania. *Proceedings of the National Academy of Sciences USA*, **100**: 11231-11236.
- TWIESELDMANN F., 1971. Belgium. In: K. P. OAKLEY, B. G. CAMPBELL & T. I. MOLLESON (ed.), *Catalogue of Fossil Hominids - Part 2: Europe*. London, Trustees of the British Museum (Natural History): 5-13.
- ULRIX-CLOSSET M., 1975. *Le Paléolithique moyen dans le bassin mosan en Belgique*. Wetteren, Éditions Universa.
- VAN DER MERWE N. J. & VOGEL J. C., 1978. ¹³C content of human collagen as a measure of prehistoric diet in Woodland North America. *Nature*, **278**: 815-816.
- VAN DER PLICHT J., WIJMA S., AERTS A. T., PERTUISOT M. H. & MEIJER H. A. J., 2000. The Groningen AMS facility: status report. *Nuclear Instruments and Methods*, **B172**: 58-65.
- VRIELYNCK O., 1999. *La chronologie de la préhistoire en Belgique. Inventaire des datations absolues*. Liège, Société wallonne de paléthnologie, Mémoire **8**.
- WHITE R., 2002. Observations technologiques sur les objets de parure. In: B. SCHMIDER (ed.), *L'Aurignacien de la Grotte du Renne: Les fouilles d'André Leroi-Gourhan à Arcy-sur-Cure (Yonne)*. Paris, CNRS Éditions: 257-266.
- WHITE M. & PETTITT P., 2012. Ancient Digs and Modern Myths: The Age and Context of the Kent's

Cavern 4 Maxilla and the Earliest *Homo sapiens* Specimens in Europe. *European Journal of Archaeology*, **15**: 392-420.

WILD E. M., TESCHLER-NICOLA M., KUTSCHERA W., STEIER P., TRINKAUS E. & WANEK W., 2005. Direct dating of Early Upper Palaeolithic human remains from Mladeč. *Nature*, **435**: 332-335.

WOLPOFF M. H., THORNE A., FRAYER D. W. & POPE G. G., 1994. Multiregional evolution: a worldwide source for modern human population. In: M. H. NITECKI & D. V. NITECKI (ed.), *Origins of Anatomically Modern Humans*. New York, Plenum Press: 175-199.

WOOD R. E., BARROSO-RUIZ C., CAPARRÓS M., JORDÁ PARDO J. F., GALVÁN SANTOS B. & HIGHAM T. F. G., 2013a. Radiocarbon dating casts doubt on the late chronology of the Middle to Upper Palaeolithic transition in southern Iberia. *Proceedings of the National Academy of Sciences USA*, **110**: 2781-2786.

WOOD R. E., HIGHAM T. F. G., DE TORRES T., TISNÉRAT-LABORDE N., VALLADAS H., ORTIZ J. E., LALUEZA-FOX C., SÁNCHEZ-MORAL S., CAÑAVÉRAS J. C., ROSAS A., SANTAMARÍA D. & DE LA RASILLA M., 2013b. A new date for the Neanderthals from El Sidrón Cave (Asturias, northern Spain). *Archaeometry*, **55**: 148-158.

ZILHÃO J., 2006. Neandertals and Moderns Mixed, and It Matters. *Evolutionary Anthropology*, **15**: 183-195.

ZILHÃO J., 2007. The Emergence of Ornaments and Art: An Archaeological Perspective on the Origins of "Behavioral Modernity". *Journal of Archaeological Research*, **15**: 1-54.

AUTHORS AFFILIATION

Patrick SEMAL¹

Anne HAUZEUR¹

Isabelle CREVECOEUR¹

Mietje GERMONPRÉ²

Stéphane PIRSON

Paul HAESAERTS

Cécile JUNGELS¹

Department of Palaeontology

¹Section of Anthropology and Prehistory

²Fossil Vertebrates

Royal Belgian Institute of Natural Sciences

29, Vautier Street

1000 Brussels

Belgium

patrick.semala@naturalsciences.be

ahauzeur@yahoo.fr

mietje.germonpre@naturalsciences.be

stef.pirson@skynet.be

paul.haesaerts@naturalsciences.be

cecilejungels@yahoo.fr

jungels@ramioul.org

Hélène ROUGIER

Department of Anthropology

California State University Northridge

18111 Nordhoff Street

Northridge, CA 91330-8244

USA

helene.rougier@csun.edu

Isabelle CREVECOEUR

Bruno MAUREILLE

CNRS

PACEA, UMR 5199

Université Bordeaux I

Avenue des Facultés

33400 Talence

France

i.crevecœur@pacea.u-bordeaux1.fr

b.maureille@pacea.u-bordeaux1.fr

Stéphane PIRSON

Michel TOUSSAINT

Direction de l'Archéologie, DGO4

Service public de Wallonie

1, rue des Brigades d'Irlande

5100 Namur

Belgium

stephane.pirson@spw.wallonie.be
mtoussaint1866@hotmail.com
michel.toussaint@spw.wallonie.be

Damien FLAS
FNRS
Département de Préhistoire
Université de Liège
7, place du XX Août
4000 Liège
Belgium
damienflas@yahoo.com

Hervé BOCHERENS
Fachbereich Geowissenschaften - Biogeologie
Universität Tübingen
Hölderlinstr. 10
72074 Tübingen
Germany
herve.bocherens@uni-tuebingen.de

Thomas HIGHAM
Oxford Radiocarbon Accelerator Unit
Research Laboratory for Archaeology and the
History of Art
Dyson Perrins Building
University of Oxford
South Parks Rd
Oxford OX1 3QY
United Kingdom
thomas.higham@rlaha.ox.ac.uk

Johannes VAN DER PLICHT
Centre for Isotope Research
Groningen University
Nijenborgh 4
9747 AG Groningen
Netherlands
and
Faculty of Archaeology
Leiden University
Reuvenplaats 3-4
2311 BE Leiden
Netherlands
J.van.der.Plicht@rug.nl